



CALL NO. 406

CONTRACT ID. 192126

HENRY - SHELBY COUNTIES

FED/STATE PROJECT NUMBER 121GR19P029 - FD05

DESCRIPTION HENRY AND SHELBY COUNTIES KY 22, KY 241, & US 421

WORK TYPE ASPHALT RESURFACING

PRIMARY COMPLETION DATE 11/15/2019

LETTING DATE: March 22,2019

Sealed Bids will be received electronically through the Bid Express bidding service until 10:00 AM EASTERN DAYLIGHT TIME March 22,2019. Bids will be publicly announced at 10:00 AM EASTERN DAYLIGHT TIME.

NO PLANS ASSOCIATED WITH THIS PROJECT.

REQUIRED BID PROPOSAL GUARANTY: Not less than 5% of the total bid.

TABLE OF CONTENTS

PART I	SCOPE OF WORK
	<ul style="list-style-type: none">• PROJECT(S), COMPLETION DATE(S), & LIQUIDATED DAMAGES• CONTRACT NOTES• STATE CONTRACT NOTES• SURFACING AREAS• ASPHALT MIXTURE• INCIDENTAL SURFACING• COMPACTION OPTION B• SPECIAL NOTE(S) APPLICABLE TO PROJECT• EDGE KEY (BY TON)• ASPHALT MILLING AND TEXTURING• BASE FAILURE REPAIR• TYPICAL SECTION DIMENSIONS• TRAFFIC CONTROL PLAN 2 LANE• DURABLE PAVEMENT EDGE DETAILS• TRAFFIC SIGNAL LOOP DETECTORS• SKETCH MAP(S)• MATERIAL SUMMARY• SUMMARY SHEET(S)• TYPICAL SECTION(S)• BRIDGE DETAIL FOR PAVING PROJECT
PART II	SPECIFICATIONS AND STANDARD DRAWINGS
	<ul style="list-style-type: none">• SPECIFICATIONS REFERENCE• SUPPLEMENTAL SPECIFICATION• 2016 STANDARD DRAWINGS THAT APPLY• CENTERLINE RUMBLE STRIP 4 INCH STRIPING• SHOULDER AND EDGE LINE RUMBLE STRIP DETAILS• EDGE LINE RUMBLE STRIP DETAILS TWO LANE ROADWAYS
PART III	EMPLOYMENT, WAGE AND RECORD REQUIREMENTS
	<ul style="list-style-type: none">• LABOR AND WAGE REQUIREMENTS• EXECUTIVE BRANCH CODE OF ETHICS• KENTUCKY EQUAL EMPLOYMENT OPPORTUNITY ACT OF 1978 LOCALITY / STATE• PROJECT WAGE RATES / STATE
PART IV	INSURANCE
PART V	BID ITEMS

PART I
SCOPE OF WORK

ADMINISTRATIVE DISTRICT - 05

CONTRACT ID - 192126

121GR19P029 - FD05

COUNTY - HENRY

PCN - MP05200221901

FD05 052 0022 000-008

BALLARDSVILLE ROAD (KY 22) (MP 0.000) BEGIN AT THE OLDHAM/HENRY COUNTY LINE EXTENDING EAST TO KY 55 (MP 7.420), A DISTANCE OF 07.42 MILES.ASPHALT RESURFACING
GEOGRAPHIC COORDINATES LATITUDE 38:21:33.00 LONGITUDE 85:14:33.00

PCN - MP05200221902

FD05 052 0022 009-017

BETHLEHEM ROAD (KY 22) (MP 9.712) BEGIN AT US 421 EXTENDING EAST TO KY 1360 (MP 16.584), A DISTANCE OF 06.87 MILES.ASPHALT RESURFACING
GEOGRAPHIC COORDINATES LATITUDE 38:23:59.00 LONGITUDE 85:04:33.00

PCN - MP05202411901

FD05 052 0241 000-002

MAIN STREET (KY 241) (MP 0.000) BEGIN AT THE SHELBY/HENRY COUNTY LINE EXTENDING NORTH TO US 421 (MP 1.147), A DISTANCE OF 01.14 MILES.ASPHALT RESURFACING
GEOGRAPHIC COORDINATES LATITUDE 38:21:06.00 LONGITUDE 85:06:39.00

PCN - MP05204211901

FD05 052 0421 007-011

NEW CASTLE HIGHWAY (US 421) (MP 7.854) BEGIN AT KY 22 EXTENDING NORTH TO KY 3322/KY 22 (MP 10.426), A DISTANCE OF 02.57 MILES.ASPHALT RESURFACING
GEOGRAPHIC COORDINATES LATITUDE 38:21:51.00 LONGITUDE 85:07:43.00

COUNTY - SHELBY

PCN - MP10604211901

FD05 106 0421 000-001

BALD KNOB ROAD (US 421) (MP 0.000) BEGIN AT THE HENRY/SHELBY COUNTY LINE EXTENDING NORTH TO THE SHELBY/HENRY (MP 0.790), A DISTANCE OF 0.79 MILES.ASPHALT RESURFACING
GEOGRAPHIC COORDINATES LATITUDE 38:20:18.00 LONGITUDE 85:04:56.00

COMPLETION DATE(S):

COMPLETED BY 11/15/2019

APPLIES TO ENTIRE CONTRACT

CONTRACT NOTES

PROPOSAL ADDENDA

All addenda to this proposal must be applied when calculating bid and certified in the bid packet submitted to the Kentucky Department of Highways. Failure to use the correct and most recent addenda may result in the bid being rejected.

BID SUBMITTAL

Bidder must use the Department's electronic bidding software. The Bidder must download the bid file located on the Bid Express website (www.bidx.com) to prepare a bid packet for submission to the Department. The bidder must submit electronically using Bid Express.

JOINT VENTURE BIDDING

Joint venture bidding is permissible. All companies in the joint venture must be prequalified in one of the work types in the Qualifications for Bidders for the project. The bidders must get a vendor ID for the joint venture from the Division of Construction Procurement and register the joint venture as a bidder on the project. Also, the joint venture must obtain a digital ID from Bid Express to submit a bid. A joint bid bond of 5% may be submitted for both companies or each company may submit a separate bond of 5%.

UNDERGROUND FACILITY DAMAGE PROTECTION

The contractor shall make every effort to protect underground facilities from damage as prescribed in the Underground Facility Damage Protection Act of 1994, Kentucky Revised Statute KRS 367.4901 to 367.4917. It is the contractor's responsibility to determine and take steps necessary to be in compliance with federal and state damage prevention directives. When prescribed in said directives, the contractor shall submit Excavation Locate Requests to the Kentucky Contact Center (KY811) via web ticket entry. The submission of this request does not relieve the contractor from the responsibility of contacting non-member facility owners, whom shall be contacted through their individual Protection Notification Center. Non-compliance with these directives can result in the enforcement of penalties.

REGISTRATION WITH THE SECRETARY OF STATE BY A FOREIGN ENTITY

Pursuant to KRS 176.085(1)(b), an agency, department, office, or political subdivision of the Commonwealth of Kentucky shall not award a state contract to a person that is a foreign entity required by [KRS 14A.9-010](#) to obtain a certificate of authority to transact business in the Commonwealth ("certificate") from the Secretary of State under [KRS 14A.9-030](#) unless the person produces the certificate within fourteen (14) days of the bid or proposal opening. If the foreign entity is not required to obtain a certificate as provided in [KRS 14A.9-010](#), the foreign entity should identify the applicable exception. Foreign entity is defined within [KRS 14A.1-070](#).

For all foreign entities required to obtain a certificate of authority to transact business in the Commonwealth, if a copy of the certificate is not received by the contracting agency within the time frame identified above, the foreign entity's solicitation response shall be deemed non-responsive or the awarded contract shall be cancelled.

Businesses can register with the Secretary of State at <https://secure.kentucky.gov/sos/ftbr/welcome.aspx>.

SPECIAL NOTE FOR PROJECT QUESTIONS DURING ADVERTISEMENT

Questions about projects during the advertisement should be submitted in writing to the Division of Construction Procurement. This may be done by fax (502) 564-7299 or email to kytc.projectquestions@ky.gov. The Department will attempt to answer all submitted questions. The Department reserves the right not to answer if the question is not pertinent or does not aid in clarifying the project intent.

The deadline for posting answers will be 3:00 pm Eastern Daylight Time, the day preceding the Letting. Questions may be submitted until this deadline with the understanding that the later a question is submitted, the less likely an answer will be able to be provided.

The questions and answers will be posted for each Letting under the heading "Questions & Answers" on the Construction Procurement website (www.transportation.ky.gov/contract). The answers provided shall be considered part of this Special Note and, in case of a discrepancy, will govern over all other bidding documents.

HARDWOOD REMOVAL RESTRICTIONS

The US Department of Agriculture has imposed a quarantine in Kentucky and several surrounding states, to prevent the spread of an invasive insect, the emerald ash borer. Hardwood cut in conjunction with the project may not be removed from the state. Chipping or burning on site is the preferred method of disposal.

INSTRUCTIONS FOR EXCESS MATERIAL SITES AND BORROW SITES

Identification of excess material sites and borrow sites shall be the responsibility of the Contractor. The Contractor shall be responsible for compliance with all applicable state and federal laws and may wish to consult with the US Fish and Wildlife Service to seek protection under Section 10 of the Endangered Species Act for these activities.

ACCESS TO RECORDS

The contractor, as defined in KRS 45A.030 (9) agrees that the contracting agency, the Finance and Administration Cabinet, the Auditor of Public Accounts, and the Legislative Research Commission, or their duly authorized representatives, shall have access to any books, documents, papers, records, or other evidence, which are directly pertinent to this contract for the purpose of financial audit or program review. Records and other prequalification information confidentially

disclosed as part of the bid process shall not be deemed as directly pertinent to the contract and shall be exempt from disclosure as provided in KRS 61.878(1)(c). The contractor also recognizes that any books, documents, papers, records, or other evidence, received during a financial audit or program review shall be subject to the Kentucky Open Records Act, KRS 61.870 to 61.884.

In the event of a dispute between the contractor and the contracting agency, Attorney General, or the Auditor of Public Accounts over documents that are eligible for production and review, the Finance and Administration Cabinet shall review the dispute and issue a determination, in accordance with Secretary's Order 11-004.

April 30, 2018

SPECIAL NOTE FOR RECIPROCAL PREFERENCE

RECIPROCAL PREFERENCE TO BE GIVEN BY PUBLIC AGENCIES TO RESIDENT BIDDERS

By reference, KRS 45A.490 to 45A.494 are incorporated herein and in compliance regarding the bidders residency. Bidders who want to claim resident bidder status should complete the Affidavit for Claiming Resident Bidder Status along with their bid in the electronic bidding software. Submittal of the Affidavit should be done along the bid in Bid Express.

April 30, 2018

FD05 052 0022 000-008

SURFACING AREAS

The Department estimates the mainline surfacing width to be 20 feet.
The Department estimates the total mainline area to be surfaced to be 110,053 square yards.
The Department estimates the shoulder width to be varied 1.5 to 2 feet on each side.
The Department estimates the total shoulder area to be surfaced to be 11,886 square yards.

FD05 052 0022 009-017

SURFACING AREAS

The Department estimates the mainline surfacing width to be 22 feet.
The Department estimates the total mainline area to be surfaced to be 90,528 square yards.
The Department estimates the shoulder width to be varied 1 to 2 feet on each side.
The Department estimates the total shoulder area to be surfaced to be 12,755 square yards.

FD05 052 0241 009-002

SURFACING AREAS

The Department estimates the mainline surfacing width to be varied 18 to 20 feet.
The Department estimates the total mainline area to be surfaced to be 16,886 square yards.
The Department estimates the shoulder width to be varied 0.5 to 3.5 feet on each side.
The Department estimates the total shoulder area to be surfaced to be 1,705 square yards.

FD05 052 0421 007-011

SURFACING AREAS

The Department estimates the mainline surfacing width to be varied 19 to 28 feet.
The Department estimates the total mainline area to be surfaced to be 39,147 square yards.
The Department estimates the shoulder width to be varied 1 to 3 feet on each side.
The Department estimates the total shoulder area to be surfaced to be 3,018 square yards.

FD05 106 0421 000-001

SURFACING AREAS

The Department estimates the mainline surfacing width to be 24 feet.
The Department estimates the total mainline area to be surfaced to be 12,235 square yards.
The Department estimates the shoulder width to be 1 foot on each side.
The Department estimates the total shoulder area to be surfaced to be 927 square yards.

ASPHALT MIXTURE

Unless otherwise noted, the Department estimates the rate of application for all asphalt mixtures to be 110 lbs/sy per inch of depth.

INCIDENTAL SURFACING

The Department has included in the quantities of asphalt mixtures established in the proposal estimated quantities required for resurfacing or surfacing mailbox turnouts, farm field entrances, residential and commercial entrances, curve widening, ramp gores and tapers, and road and street approaches, as applicable. Pave these areas to the limits as shown on Standard Drawing RPM-110-06 or as directed by the Engineer. In the event signal detectors are present in the intersecting streets or roads, pave the crossroads to the right of way limit or back of the signal detector, whichever is the farthest back of the mainline. Surface or resurface these areas as directed by the Engineer. The Department will not measure placing and compacting for separate payment but shall be incidental to the Contract unit price for the asphalt mixtures.

OPTION B

Be advised that the Department will control and accept compaction of asphalt mixtures furnished on this project under OPTION B in accordance with Sections 402 and 403.

SPECIAL NOTE FOR NON-TRACKING TACK COAT

1. DESCRIPTION AND USEAGE. This specification covers the requirements and practices for applying a non-tracking tack asphalt coating. Place this material on the existing pavement course, prior to placement of a new asphalt pavement layer. Use when expedited paving is necessary or when asphalt tracking would negatively impact the surrounding area. This material is not suitable for other uses. Ensure material can “break” within 15 minutes under conditions listed in 3.2.

2. MATERIALS, EQUIPMENT, AND PERSONNEL.

2.1 Non-Tracking Tack. Provide material conforming to Subsection 2.1.1.

2.1.1 Provide a tack conforming to the following material requirements:

Property	Specification	Test Procedure
Viscosity, SFS, 77 ° F	20 – 100	AASHTO T 72
Sieve, %	0.3 max.	AASHTO T 59
Asphalt Residue ¹ , %	50 min.	AASHTO T 59
Oil Distillate, %	1.0 max.	AASHTO T 59
Residue Penetration, 77 ° F	20 max.	AASHTO T 49
Original Dynamic Shear (G*/sin δ), 82 ° C	1.0 min.	AASHTO T 315
Softening Point, ° F	149 min.	AASHTO T 53
Solubility, %	97.5 min.	AASHTO T 44

¹ Bring sample to 212 °F over a 10-15 minute period. Maintain 212 °F for 15-20 minutes or until 30-40 mL of water has distilled. Continue distillation as specified in T59.

2.2. Equipment. Provide a distributor truck capable of heating, circulating, and spraying the tack between 170 °F and 180 °F. Do not exceed 180 °F. Circulate the material while heating. As required by the manufacturer, ensure the spray bar is equipped with #1 or #2 ¼” V-slot Etnyre nozzles. Other nozzles are not acceptable. Arrange the nozzles in the following patterns from left to right:

Nozzle number(s)	Activity	Orientation
1	On	Vertical
2	Off	-
3	On	Horizontal
4 & 5	Off	-
6	On	Horizontal
Continue 2 off and 1 on pattern through rest of spray bar system.		

Ensure the bar can be raised to between 14 and 18” from the roadway.

2.3 Personnel. Ensure the tack supplier has provided training to the contractor on the installation procedures for this product. Make a technical representative from the supplier available at the request of the Engineer.

3. CONSTRUCTION.

3.1 Surface Preparation. Prior to the application of the non-tracking tack, ensure the pavement surface is thoroughly dry and free from dust or any other debris that would inhibit adhesion. Clean the surface by scraping, sweeping, and the use of compressed air. Ensure this preparation process occurs shortly before application to prevent the return of debris pavement. If rain is expected within one hour after application, do not apply material. Apply material only when the surface is dry, and no precipitation is expected.

3.2 Non-tracking Tack Application. Ensure the roadway temperature is a minimum of 40 °F and rising during the application of the tack. This material is not suitable for use in colder temperatures. Prior to applying the tack, demonstrate competence in applying the tack according to this note to the satisfaction of the Engineer. Heat the tack in the distributor to between 170 – 180 °F. After initial heating to between 170 – 180 °F, the material may be sprayed between 165 °F and 180 °F. Do not apply outside this temperature range. Apply material at a rate of 0.50 pounds (0.06 gallons) per square yard. Ensure full coverage of the material on the pavement surface. Full coverage of this material is critical. If full coverage is not achieved, material application rate may be increased to ensure full coverage. Do not heat material more than twice in one day.

3.3 Non-tracking Tack Certification. Furnish the tacks certification to the Engineer stating the material conforms to all requirements herein prior to use.

3.4 Sampling and Testing. The Department will require a sample of non-tracking tack be taken from the distributor at a rate of one sample per 15,000 tons of mix. Take two 1 gallon samples of the heated material and forward the sample to the Division of Materials for testing within 7 days. Ensure the product temperature is between 170 and 180 °F at the time of sampling.

4. MEASUREMENT. The Department will measure the quantity of non-tracking tack in tons. The Department will not measure for payment any extra materials, labor, methods, equipment, or construction techniques used to satisfy the requirements of this note. The Department will not measure for payment any trial applications of non-tracking tack, the cleaning of the pavement surface, or furnishing and placing the adhesive. The Department will consider all such items incidental to the non-tracking tack.

5. PAYMENT. The Department will pay for the non-tracking tack at the Contract unit bid price and apply an adjustment for each manufacturer's lot of material based on the degree of compliance as defined in the following schedule. When a sample fails on two or more tests, the Department may add the deductions, but the total deduction will not exceed 100 percent.

Non-Tracking Tack Price Adjustment Schedule						
Test	Specification	100% Pay	90% Pay	80% Pay	50% Pay	0% Pay
Viscosity, SFS, 77 ° F	20 – 100	19 - 102	17 - 18	15 - 16	14	≤13
			103 - 105	106 - 107	108 - 109	≥ 110
Sieve, %	0.30 max.	≤ 0.40	0.41 - 0.50	0.51 - 0.60	0.61 - 0.70	≥ 0.71
Asphalt Residue, %	50 min.	≥49.0	48.5 – 48.9	48.0 – 48.4	47.5-47.9	≤ 47.4
Oil Distillate, %	1.0 max.	≤1.0	1.1-1.5	1.6 - 1.7	1.8-1.9	>2.0
Residue Penetration, 77 ° F	20 max.	≤ 21	22 - 23	24 - 25	26 - 27	≥ 28
Original Dynamic Shear (G*/sin δ), 82 ° C	1.0 min.	≥0.95	0.92 – 0.94	0.90 – 0.91	0.85 - 0.89	≤ 0.84
Softening Point, ° F	149 min.	≥145	142 - 144	140 - 141	138 - 139	≤ 137
Solubility, %	97.5 min.	≥ 97.0	96.8 – 96.9	96.6 – 96.7	96.4 – 96.5	≤ 96.3

<u>Code</u>	<u>Pay Item</u>	<u>Pay Unit</u>
24970EC	Asphalt Material for Tack Non-Tracking	Ton

April 30, 2018

SPECIAL NOTE FOR EDGE KEY

Construct Edge Keys at the beginning of project, end of project, at railroad crossings, and at ramps, as applicable. Unless specified in the Contract or directed by the Engineer, do not construct edge keys at intersecting streets, roads, alleys, or entrances. Cut out the existing asphalt surface to the required depth and width shown on the drawing and heel the new surface into the existing surface. The Department will make payment for this work at the Contract unit price per ton for Asphalt Pavement Milling and Texturing, which shall be full compensation for all labor, materials, equipment, and incidentals for removal and disposal of the existing asphalt surface required to construct the edge key.

EDGE KEY

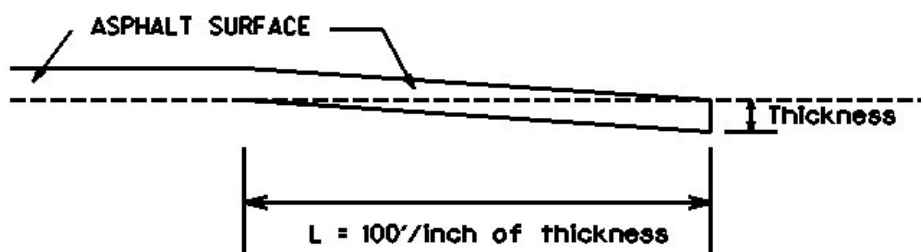

Thickness = **1.0** Inches

L = **100** LF

L = Length of Edge Key

**SPECIAL NOTE FOR
ASPHALT MILLING AND TEXTURING**

Begin paving operations within **48 hours** of commencement of the milling operation. Continue paving operations continuously until completed. If paving operations are not begun within this time period, the Department will assess liquidated damages at the rate prescribed by Section 108.09 until such time as paving operations are begun.

Take possession of the millings and recycle the millings or dispose of the millings off the Right-of-Way at sites obtained by the Contractor at no additional cost to the Department.

1-3520 48 hours Contractor keeps millings
01/2/2012

FD05 056 0022 000-008
FD05 056 0022 009-017
SPECIAL NOTE FOR BASE FAILURE REPAIR

Repair locations listed on the summary are approximate only. The Engineer will determine actual repair locations and dimensions at the time of construction. Prior to overall milling and/or leveling and wedging, excavate the designated base failure areas to a depth 6 inches below the existing asphalt pavement surface level. Dispose of the excavated materials at waste sites off the Right-of-Way obtained by the Contractor at no additional cost to the Department. See Special Note for Waste and Borrow.

Backfill the excavated areas with Class 2 Asphalt Base 1.00D PG64-22. Compact the asphalt base to the compaction required in Section 403.03.10. Seal the asphalt base with leveling and wedging. Perform all base failure repairs in such a manner that removal and replacement are completed on the same day. Do this work as one of the Contractor's first operations in order to allow further compaction by traffic. Do not mill or place new asphalt surface over repaired base failure areas until a minimum of 7 calendar days have elapsed after placement of the asphalt base. After a minimum of 7 calendar days and when the Engineer determines the base failure repair areas have sufficiently stabilized, begin milling and/or resurfacing operations. Prior to milling and/or constructing the new asphalt surface, level and wedge any settlement of the repair areas.

The bidder must draw conclusions as to the conditions encountered. The Department does not give any guarantee as to the accuracy of the data and will not consider any claim for additional compensation if the materials encountered that are not in accord with the classification shown.

Accept payment at the Contract unit prices per square yard for Base Failure repair and per ton for Leveling and Wedging as full compensation for all labor, materials, equipment, and incidentals for removing pavement and disposing of the materials, furnishing and placing asphalt base, leveling and wedging, and all other items necessary to complete the work according to these notes to the satisfaction of the Engineer.

FD05 106 0421 000-001
SPECIAL NOTE FOR BASE FAILURE REPAIR

Repair locations listed on the summary are approximate only. The Engineer will determine actual repair locations and dimensions at the time of construction. Prior to overall milling and/or leveling and wedging, excavate the designated base failure areas to a depth 4 inches below the existing asphalt pavement surface level. Dispose of the excavated materials at waste sites off the Right-of-Way obtained by the Contractor at no additional cost to the Department. See Special Note for Waste and Borrow.

Backfill the excavated areas with Class 2 Asphalt Base 1.00D PG64-22. Compact the asphalt base to the compaction required in Section 403.03.10. Seal the asphalt base with leveling and wedging. Perform all base failure repairs in such a manner that removal and replacement are completed on the same day. Do this work as one of the Contractor's first operations in order to allow further compaction by traffic. Do not mill or place new asphalt surface over repaired base failure areas until a minimum of 7 calendar days have elapsed after placement of the asphalt base. After a minimum of 7 calendar days and when the Engineer determines the base failure repair areas have sufficiently stabilized, begin milling and/or resurfacing operations. Prior to milling and/or constructing the new asphalt surface, level and wedge any settlement of the repair areas.

The bidder must draw conclusions as to the conditions encountered. The Department does not give any guarantee as to the accuracy of the data and will not consider any claim for additional compensation if the materials encountered that are not in accord with the classification shown.

Accept payment at the Contract unit prices per square yard for Base Failure repair and per ton for Leveling and Wedging as full compensation for all labor, materials, equipment, and incidentals for removing pavement and disposing of the materials, furnishing and placing asphalt base, leveling and wedging, and all other items necessary to complete the work according to these notes to the satisfaction of the Engineer.

SPECIAL NOTE FOR TYPICAL SECTION DIMENSIONS

Consider the dimensions shown on the typical sections for pavement and shoulder widths and thickness' to be nominal or typical dimensions. The Engineer may direct or approve varying the actual dimensions to be constructed to fit existing conditions. Do not widen existing pavement or shoulders unless specified elsewhere in this proposal or directed by the engineer.

1-3725 Typical Section Dimensions
01/02/2012

TRAFFIC CONTROL PLAN

TRAFFIC CONTROL GENERAL

Except as provided herein, maintain and control traffic in accordance with the Standard and Supplemental Specifications and the Standard and Sepia Drawings, current editions. Except for the roadway and traffic control bid items listed, all items of work necessary to maintain and control traffic will be paid at the lump sum bid price to "Maintain and Control Traffic".

Contrary to Section 106.01, furnish new, or used in like new condition, traffic control devices at the beginning of the work and maintain in like new condition until completion of the work.

PROJECT PHASING & CONSTRUCTION PROCEDURES

The Engineer may specify days and hours when lane closures will not be allowed.

Maintain alternating one way traffic during construction. Provide a minimum clear lane width of KY 22 (9 feet), KY 241 (8 feet), US 421 007-011 (8.5 feet) and, US 421 000-001 (11 feet); however, provide for passage of vehicles of up to 16 feet in width. If traffic should be stopped due to construction operations, and a school bus on an official run arrives on the scene, make provisions for the passage of the bus as quickly as possible.

LANE CLOSURES

Do not leave lane closures in place during non-working hours.

SIGNS

Sign posts and splices shall be compliant with NCHRP 350 or MASH. Manufacturer's documentation validating this compliance shall be provided to the Engineer prior to installation. Signs, including any splices, shall be installed according to manufacturer's specifications and installation recommendations. Contrary to section 112.04.02, only long-term signs (signs intended to be continuously in place for more than 3 days) will be measured for payment. Short-term signs (signs intended to be left in place for 3 days or less) will not be measured for payment but will be incidental to Maintain and Control Traffic.

CHANGEABLE MESSAGE SIGNS

If deemed necessary by the Engineer, the Department will furnish, operate, and maintain Changeable Message Signs.

Traffic Control Plan
Page 2 of 3

TEMPORARY ENTRANCES

The Engineer will not require the Contractor to provide continuous access to farms, single family, duplex, or triplex residential properties during working hours; however, provide reasonable egress and ingress to each such property when actual operations are not in progress at that location. Limit the time during which a farm or residential entrance is blocked to the minimum length of time required for actual operations, not extended for the Contractor's convenience, and in no case exceeding six (6) hours. Notify all residents twenty-four hours in advance of any driveway or entrance closings and make any accommodations necessary to meet the access needs of disabled residents.

Except as allowed by the Phasing as specified above, maintain direct access to all side streets and roads, schools, churches, commercial properties and apartments or apartment complexes of four or more units at all times.

The Department will measure asphalt materials required to construct and maintain any temporary entrances which may be necessary to provide temporary access; however, the Department will not measure aggregates, excavation, and/or embankment, but shall be incidental to Maintain and Control Traffic. The Engineer will determine the type of surfacing material, asphalt or aggregate, to be used at each entrance.

TRAFFIC SIGNAL LOOPS

Install traffic signal loops according to the Special Notes for Traffic Signal Loop Replacement. Coordinate the placement of the loops with the Engineer.

THERMOPLASTIC INTERSECTION MARKINGS

Consider the locations listed on the summary as approximate only. Prior to milling and/or resurfacing, locate and document the locations of the existing markings. After resurfacing, replace the markings at their approximate existing locations or as directed by Engineer. Place markings not existing prior to resurfacing as directed by the Engineer.

BARRICADES

The Department will not measure barricades used in lieu of barrels and cones for channelization or delineation, but shall be incidental to Maintain and Control Traffic according to Section 112.04.01.

The Department will measure barricades used to protect pavement removal areas in individual units Each. The Department will measure for payment the maximum number of barricades in concurrent use at the same time on a single day on all sections of the contract. The Department will measure individual barricades only once for payment, regardless of how many times they are set, reset, removed, and relocated during the duration of the project. The Department will not

Traffic Control Plan
Page 3 of 3

measure replacements for damaged barricades the Engineer directs to be replaced due to poor condition or reflectivity. Retain possession of the Barricades upon completion of construction.

PAVEMENT MARKINGS

If there is to be a deviation from the existing striping plan, the Engineer will furnish the Contractor a striping plan prior to placement of the final surface course.

Install Temporary Striping according to Section 112 with the following exception:

If the Contractor's operations or phasing requires temporary markings that must subsequently be removed from the final surface course, use an approved removable lane tape; however, the Department will not measure removable lane tape for separate payment, but will measure and pay for removable lane tape as temporary striping.

PAVEMENT EDGE DROP-OFFS

Do not allow a pavement edge between opposing directions of traffic or lanes that traffic is expected to cross in a lane change situation with an elevation difference greater than 1½". Place Warning signs (MUTCD W8-11 or W8-9A) in advance of and at 1500' intervals throughout the drop-off area. Dual post the signs on both sides of the traveled way. Wedge all transverse transitions between resurfaced and unresurfaced areas which traffic may cross with asphalt mixture for leveling and wedging. Remove the wedges prior to placement of the final surface course.

Protect pavement edges that traffic is not expected to cross, except accidentally, as follows:

Less than 2" - No protection required.

2" to 4" - Place plastic drums, vertical panels, or barricades every 50 feet. During daylight working hours only, the Engineer will allow the Contractor to use cones in lieu of plastic drums, panels, and barricades. Wedge the drop-off with DGA or asphalt mixture for leveling and wedging with a 1:1 or flatter slope in daylight hours, or 3:1 or flatter slope during nighttime hours, when work is not active in the drop-off area.

Greater than 4" - Protect drop-offs greater than 4 inches within 10 feet of traffic by placing drums, vertical panels, or barricades every 25 feet. The Engineer will not allow the use of cones in lieu of drums, vertical panels, or barricades for drop-offs greater than 4". Place Type III Barricades directly in front of the drop-off facing on coming traffic in both directions of travel. Provide warning signs as shown on the Standard Drawings or as directed by the Engineer

Pedestrians & Bicycles - Protect pedestrian and bicycle traffic as directed by the engineer.

DURABLE PAVEMENT EDGE DETAIL

(Resurfacing adjacent to low shoulder with dropoff of 5 inches or less)

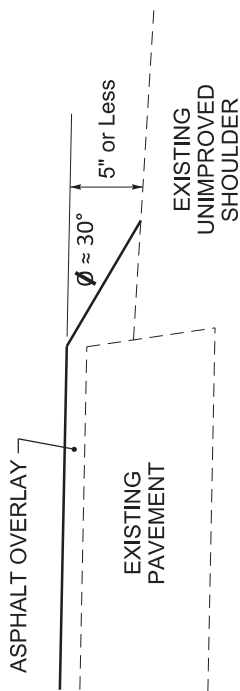

DURABLE PAVEMENT EDGE DETAIL

(Resurfacing adjacent to fill slope or ditch foreslope that is 3:1 or less)

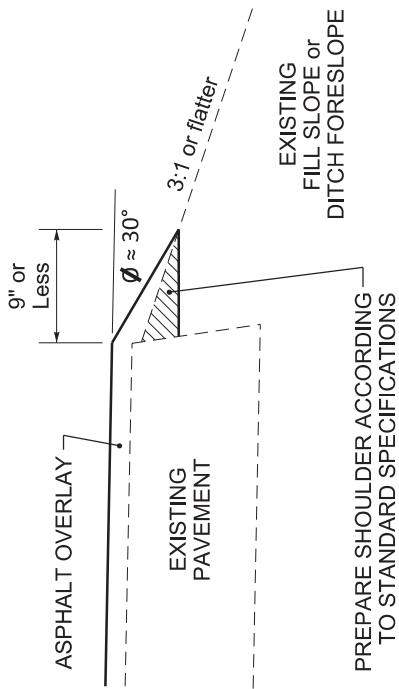

DURABLE PAVEMENT EDGE DETAIL

(Resurfacing adjacent to low shoulder with dropoff of more than 5 inches)

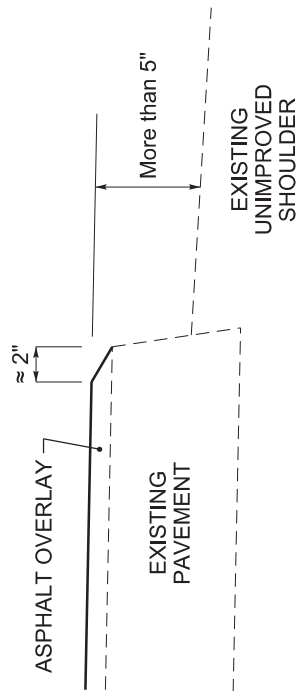

DURABLE PAVEMENT EDGE DETAIL

(Resurfacing adjacent to fill slope or ditch foreslope that is steeper than 3:1)

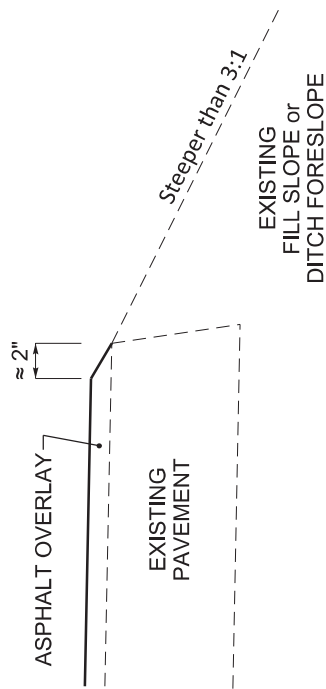

DURABLE PAVEMENT EDGE DETAIL

(Resurfacing adjacent to an obstruction, such as an existing headwall)

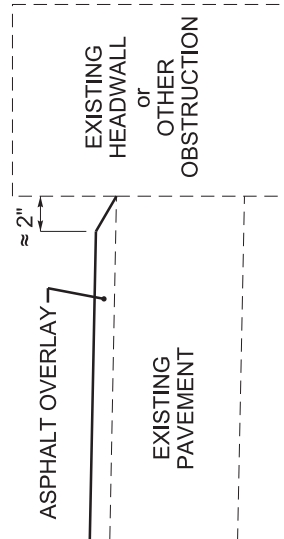

NOTES

1. DETAILS DO NOT APPLY TO OVERLAYS LESS THAN 1 INCH THICK.
2. THE DURABLE PAVEMENT EDGE DEVICE MAY BE DISENGAGED AT DRIVEWAYS, SIDE STREETS, HIGH SHOULDERS, AND OTHER LOCATIONS NOT FEASIBLE TO CONSTRUCT, AS APPROVED BY THE ENGINEER.

DRAWING NOT TO SCALE

DURABLE PAVEMENT EDGE DETAILS

SPECIAL NOTE FOR TRAFFIC SIGNAL LOOP DETECTORS

1.0 DESCRIPTION. Be advised that there are existing traffic signal loop detectors within the construction limits of this project. Except as specified herein, perform traffic signal loop replacement in accordance with the Department's Standard/Supplemental Specifications, Special Provisions, Special Notes, and Standard/Sepia Drawings, current editions and as directed by the Engineer. Article references are to the Standard Specifications. Furnish all materials, labor, equipment, and incidentals for replacement of traffic signal loop installation(s) and all other work specified as part of this contract.

1.1 Pre-bid Requirements. Each Contractor submitting a bid for this work shall make a thorough inspection of the site prior to submitting his bid and shall thoroughly familiarize himself with existing conditions so that the work can be expeditiously performed after a Contract is awarded. Information provided in the Plans regarding types and quantities of work is not to be taken as an accurate or complete evaluation of the materials and conditions to be encountered during construction. The bidder must make his own determinations as to the conditions encountered.

2.0 MATERIALS. Except as specified herein, furnish materials in accordance with Subsection 732.02 and Section 835. Provide for materials to be sampled and tested in accordance with the Department's Sampling Manual. Make materials available for sampling a sufficient time in advance of the use of the materials to allow for the necessary time for testing, unless otherwise specified in this Special Note.

2.1 Maintain and Control Traffic. See Traffic Control Plan.

2.2 Sand. Furnish natural sand meeting the requirements of Subsection 804.04.01.

2.3 Seeding. Furnish Seed Mix Type I.

2.4 Loop Saw Slot and Fill. Furnish loop sealant, backer rod, and non-shrink grout according to the Saw Slot Detail.

2.5 Junction Boxes. Furnish junction box type B, #57 aggregate, and geotextile filter type IV according to junction box detail.

2.6 Cable No. 14/1 Pair (Lead-in). Furnish cable that is specified in Section 835. Cable shall be ran splice free. This shall include splice kits to connect to the loop wire.

2.7 Conduit. Furnish and install appropriate conduit from transitions to the roadway, junction boxes and poles. See details below.

3.0 CONSTRUCTION. Except as specified herein, install and test Traffic Signal Loop Detectors in accordance with Section 723 and the drawings.

3.1 Testing. The Contractor shall test all loops and cable no. 14/1 pair (lead-in) according to Subsection 723.03.17 before and after milling the roadway. The Contractor may have to separate the loop from the lead-in to perform this test. If the loop/lead-in meets the requirement in Section 723 at the controller cabinet, the loop/lead-in shall not be replaced. If existing loops do not meet the requirements in Subsection 723.03.17, the loops shall be replaced. Replacement loops may be installed either before or after the milling process.

Traffic Signal Loop Detectors Page 2 of 8

The Contractor shall verify that loops (both existing and replacement loops) meet the requirements per Subsection 723.03.17 before the final surface is laid. If loops do not meet conditions of Subsection 723.03.17, the Contractor shall replace them before the resurfacing activities begin. If replacement loops have to be reinstalled, the costs of reinstallation shall be incidental to the milling bid item. The Contractor shall re-splice loops to the lead-in with the proper splice as noted in the spec book.

3.2 Coordination. Notify the Engineer in writing, two (2) weeks prior to beginning any work. The Engineer will contact the District Traffic Engineer to coordinate the Department's operations with the Contractor's work.

3.3 Connection. The Contractor shall schedule all signal loop installation to ensure the new loops are connected to the lead-in and operational within 5 calendar days of the old loops being damaged and/or disconnected. This requirement includes damage caused by any work activity associated with the project. If the new signal loops are not functioning as intended following 5 calendar days, the Department may assess Liquidated Damages at a rate of \$500 per calendar day per signal location until the loops are operating at pre-construction conditions. All liquidated damages will be applied cumulatively.

3.4 Maintain and Control Traffic. See Traffic Control Plan.

3.5 Milling. On projects involving milling and texturing of the existing pavement, install loops in the existing pavement before or after performing the milling and texturing. After milling, the remnant contents of the existing saw slot (grout, loop wires, backer rod, and/or loop sealant) may not be flush with the top of the milled portion of the surface. In such cases, clear the saw slot of loose remnant contents and refill the saw slot with natural sand. Obtain the Engineer's approval of the stabilized saw slot prior to resurfacing. The Department will not measure for separate payment clearing and stabilizing the saw slot and shall consider this work incidental to milling.

3.6 Loop Saw Slot and Fill. The following is a typical step by step procedure for the installation of a loop.

- 1) Carefully mark the slot to be cut, perpendicular to the flow of traffic and centered in the lane.
- 2) Make each saw-cut 3/8-inch wide and at a depth such that the top of the backer rod is a minimum of 4 inches below the surface of asphalt pavement.
- 3) Drill a 1½ inch core hole at each corner and use a chisel to smooth corners to prevent sharp bends in the wire.
- 4) Clean all foreign and loose matter out of the slots and drilled cores and within 1 foot on all sides of the slots using a high pressure washer.
- 5) Completely dry the slots and drilled cores and within 1 foot on all sides of the slots.
- 6) Measure 9-12 inches from the edge of the paved surface (shoulder break or face of curb) and drill a 1½ inch hole on a 45° angle to the conduit adjacent to the roadway.
- 7) Closely inspect all cuts, cores, and slots for jagged edges or protrusions prior to the placement of the wire. All jagged edges and protrusions shall be ground or re-cut and cleaned again.

Traffic Signal Loop Detectors

Page 3 of 8

- 8) Place the loop wire splice-free from the termination point (cabinet or junction box) to the loop, continue around the loop for two turns (6'x30' loop) or three turns (6'x6' loop), and return to the termination point.
- 9) Push the wire into the saw slot with a blunt object such as a wooden stick. Make sure that the loop wire is pushed fully to the bottom of the saw slot. Screwdrivers shall not be used.
- 10) Install duct sealant to a minimum of 1 inch deep into the cored 1½ inch hole.
- 11) Apply loop sealant from the bottom up and fully encapsulate the loop wires in the saw slot. The wire should not be able to move when the sealant has set.
- 12) Cover the encapsulated loop wire with a continuous layer of backer rod along the entire loop and home run saw slots such that no voids are present between the loop sealant and backer rod.
- 13) Finish filling the saw cut with non-shrinkable grout per manufacturer's instructions. Alleviate all air pockets and refill low spaces. There shall be no concave portion to the grout in the saw slot. Any excess grout shall be cleaned from the roadway to alleviate tracking.
- 14) Clean up the site and dispose of all waste off the project.
- 15) Ensure that the grout has completely cured prior to subjecting the loop to traffic. Curing time varies with temperature and humidity.

3.7 Final Dressing, Clean Up, and Seeding. After all work is completed, clean work sites and all disturbed areas. Dispose of all waste and debris off the right of way at sites obtained by the Contractor at no additional cost to the Department. Sow all disturbed earthen areas with Seed Mix Type I.

3.8 Removal. The Contractor shall remove all existing junction boxes, wire from spans/poles/junction boxes/conduits, and conduits. The removal will be incidental to the project.

3.9 Property/Roadway Damage. The Contractor shall be responsible for all damage to public and/or private property resulting from the work. Upon completion of the work, restore all disturbed highway features and private property in like kind design and materials at no additional cost to the Department.

3.10 Right-of-Way Limits. The Department has not established exact limits of Right-of-Way. Limit work activities to obvious Right-of-Way and work areas secured by the Department through Consent and Release of the adjacent property owners. Contractor is responsible for all encroachments onto private lands.

3.11 Utility Clearance. Work around and do not disturb existing utilities. The Department does not anticipate any utility impacts for loop installation. If utilities are impacted, work with associated utility companies to resolve issues.

3.12 Control. Obtain the Engineer's approval of all designs required to be furnished by the Contractor prior to incorporation into the work. The Department reserves the right to permit other contractors, state forces, public utility companies, and others to do work during the construction within the limits of, or adjacent to, the project. Conduct operations and cooperate with such other parties so that interference with each other's work will be reduced to a minimum. The Contractor agrees to make no claims against the Department for additional compensation due to delays or other conditions created by

Traffic Signal Loop Detectors
Page 4 of 8

the operations of such other parties. Should a difference of opinion arise as to the rights of the Contractor and others working within the limits of, or adjacent to, the project, the Engineer will decide as to the respective rights of the various parties involved in order to ensure the completion of the work in general harmony and in a satisfactory manner, and the Engineer's decision shall be final and binding upon the Contractor.

3.13 Bore and Jack. Except for situations outlined in 3.15, bore and jack will be used if conduit is under pavement of any kind. The conduit shall be 2" rigid steel conduit under all pavement areas except for the area where the loop transitions from the saw slot. The installation of conduit should follow the below detail.

3.14 Open Cut Roadway. With permission of the Engineer, roadway may be open cut if the conduit is under pavement. The conduit shall be 2" rigid steel conduit under all pavement areas except for the area that the loop transition from the saw slot. The installation of conduit should follow requirements per Section 723.

4.0 MEASUREMENT. See Subsection 723.04 for bid item notes. Additional bid items include the following:

4.1 Loop Test. The Department will measure the quantity as each individual unit loop tested. The Department will not measure disconnection, reconnection, traffic control, re-splicing per specifications, before and after testing per note above, and any associated hardware for payment and will consider them incidental to this item of work.

5.0 PAYMENT. The Department will make payment for the completed and accepted quantities of listed items according to Subsection 723.05 in addition to the following:

<u>Code</u>	<u>Pay Item</u>	<u>Pay Unit</u>
Conduit 1"	4792	Linear Foot
PVC Conduit – 1 ¼ inch – sch 80	24900EC	Linear Foot
PVC Conduit – 2 inch – sch 80	24901EC	Linear Foot
Conduit 2"	4795	Linear Foot
Electrical Junction Box type B	4811	Each
Loop Test	24963ED	Each
Trenching and Backfilling	4820	Linear Foot
Loop Wire	4830	Linear Foot
Cable-No. 14/1 Pair	4850	Linear Foot ¹
Loop Saw Slot and Fill	4895	Linear Foot ¹
Bore and Jack Conduit	21543EN	Linear Foot ³
Open Cut Roadway	4821	Linear Foot ³

The Department will consider payment as full compensation for all work required under these notes and the Standard Specifications.

Traffic Signal Loop Detectors

Page 5 of 8

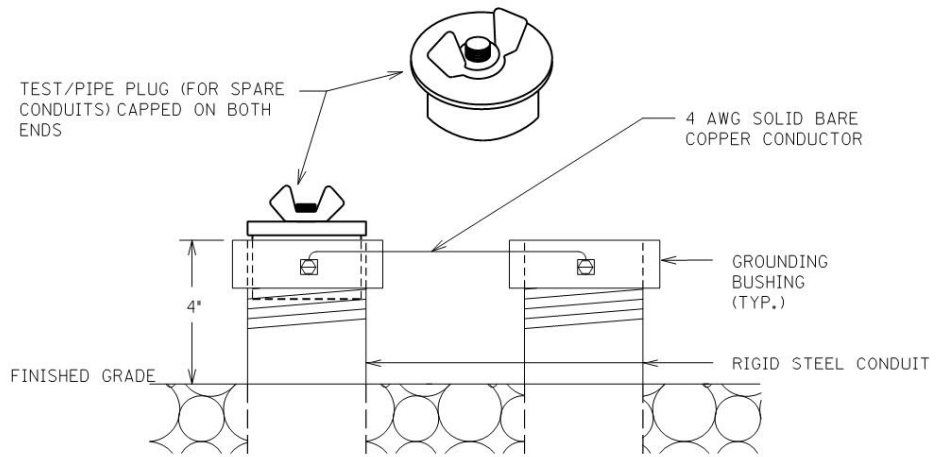

TEST/PIPE PLUG(FOR SPARE CONDUITS) AND GROUNDING DETAIL

Traffic Signal Loop Detectors
Page 6 of 8

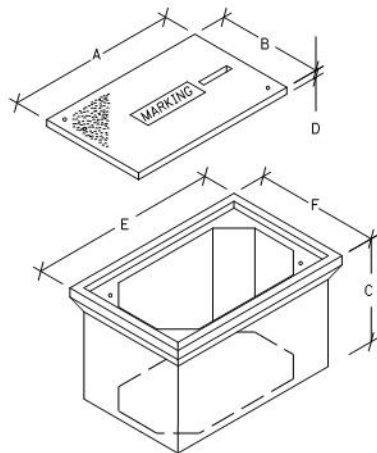

JUNCTION BOX DIMENSIONS (NOMINAL)						
	A	B	C	D	E	F
TYPE A	23"	14"	27"	2"	25"	15"
TYPE B	18"	11"	12"	1 3/4"	20"	13"
TYPE C	36"	24"	30"	3"	38"	26"

• MINIMUM
NOTE: STACKABLE BOXES ARE PERMITTED

BEFORE THE INSTALLATION OF THE #57 AGGREGATE AND JUNCTION BOX, THE CONTRACTOR SHALL INSTALL GEOTEXTILE FILTER FABRIC TYPE IV IN THE HOLE. THE FABRIC SHALL EXTEND TO JUST BELOW THE LIP OF THE JUNCTION BOX AND SHALL BE CONTINUOUSLY ADHERED TO THE EXTERIOR OF THE BOX WITH ADHESIVE. ANY LOCATIONS WHERE CONDUITS ENTER THE BOX, THE FABRIC SHALL BE 'X CUT' ONLY AS MUCH AS NECESSARY TO ALLOW PASSAGE OF EACH INDIVIDUAL CONDUIT THROUGH THE FABRIC. THE FABRIC SHALL BE INCIDENTAL TO BID ITEMS 481I, 2039INS835, OR 20392NS835.

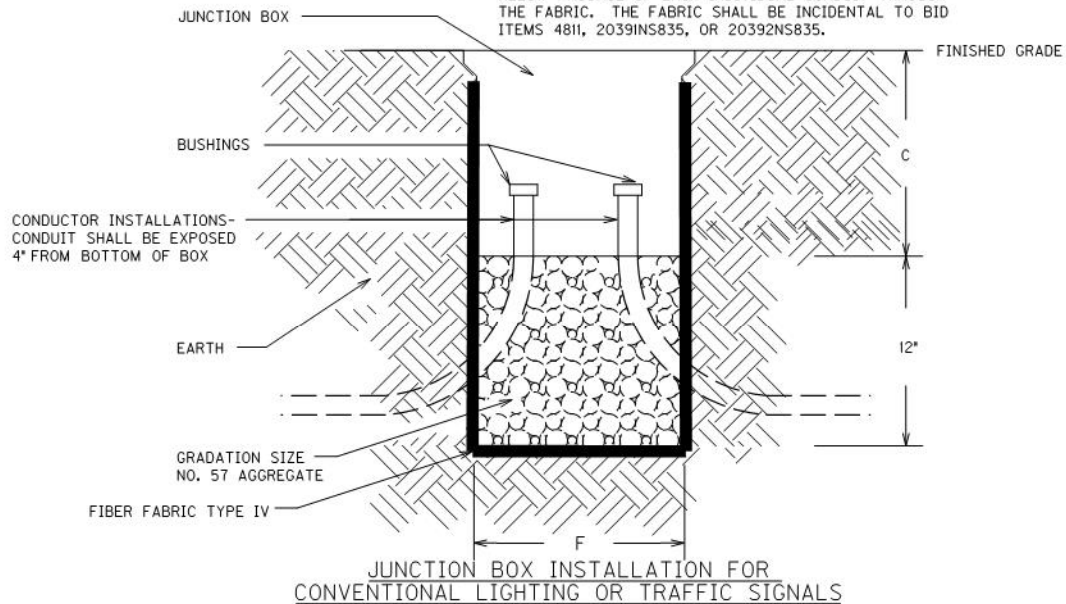

JUNCTION BOX INSTALLATION FOR CONVENTIONAL LIGHTING OR TRAFFIC SIGNALS

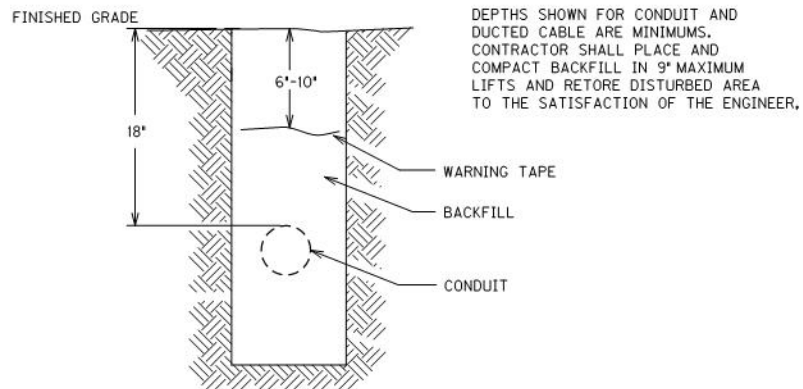

CONDUIT AND WARNING TAPE TRENCH

Traffic Signal Loop Detectors

Page 7 of 8

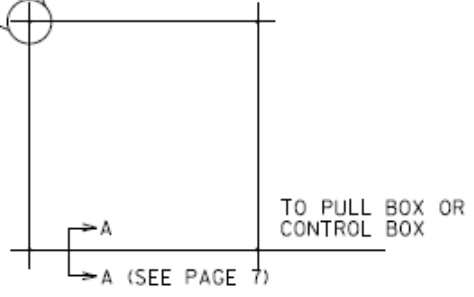
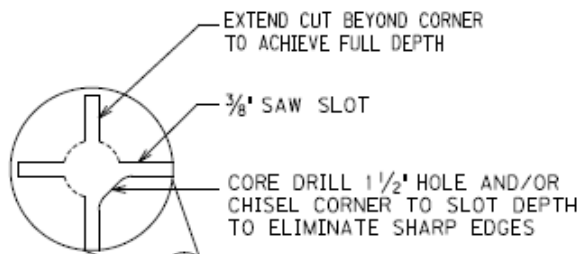

SAW CUT PLAN

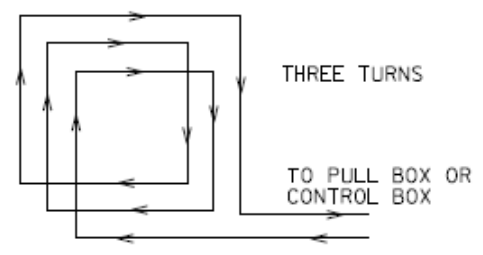

WIRING PLAN

6'X6' LOOP

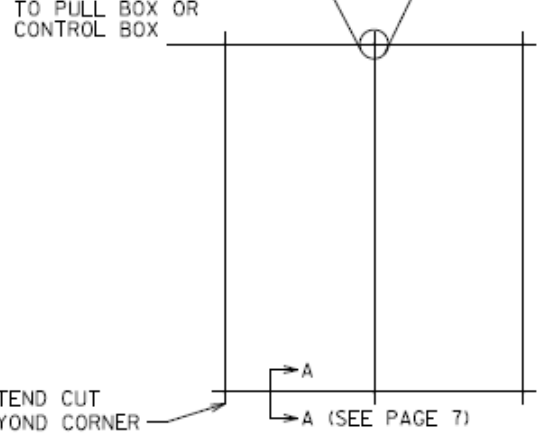
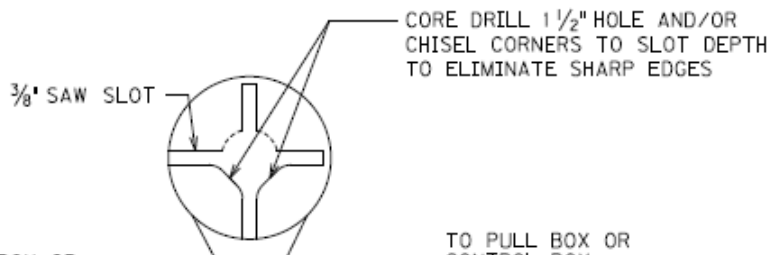

SAW CUT PLAN

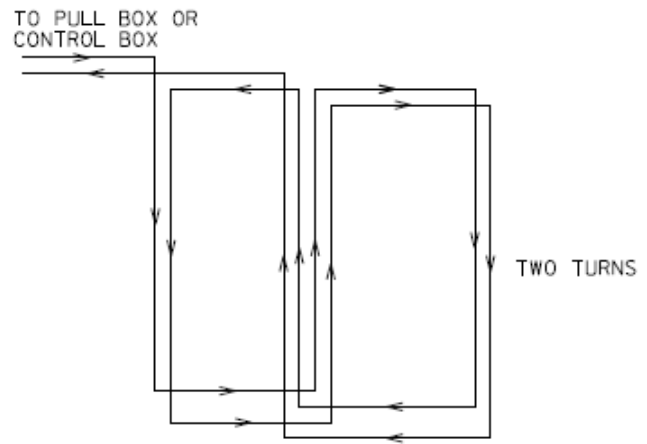

WIRING PLAN

6'X30' QUADRAPOLE LOOP

Traffic Signal Loop Detectors

Page 8 of 8

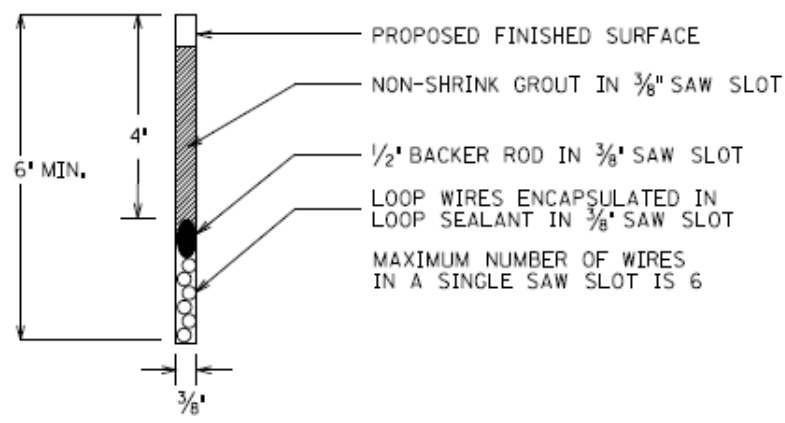

SECTION A-A (SAW SLOT DETAIL)

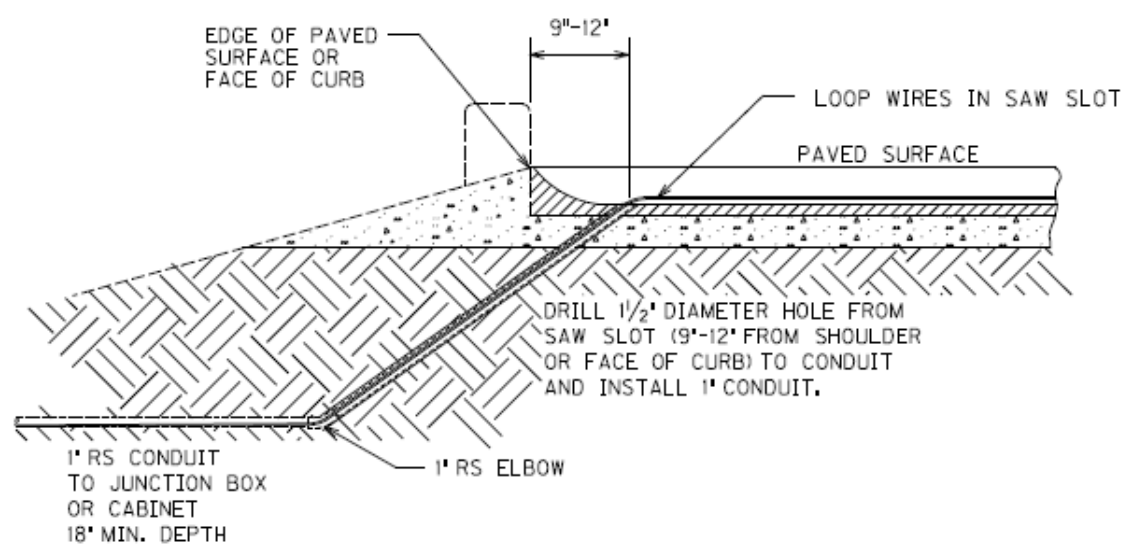

SAW SLOT EDGE OF PAVEMENT TRANSITION

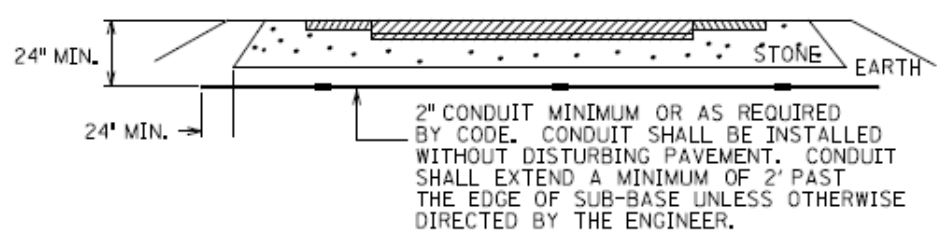

CONDUIT UNDER EXISTING PAVEMENT DETAIL

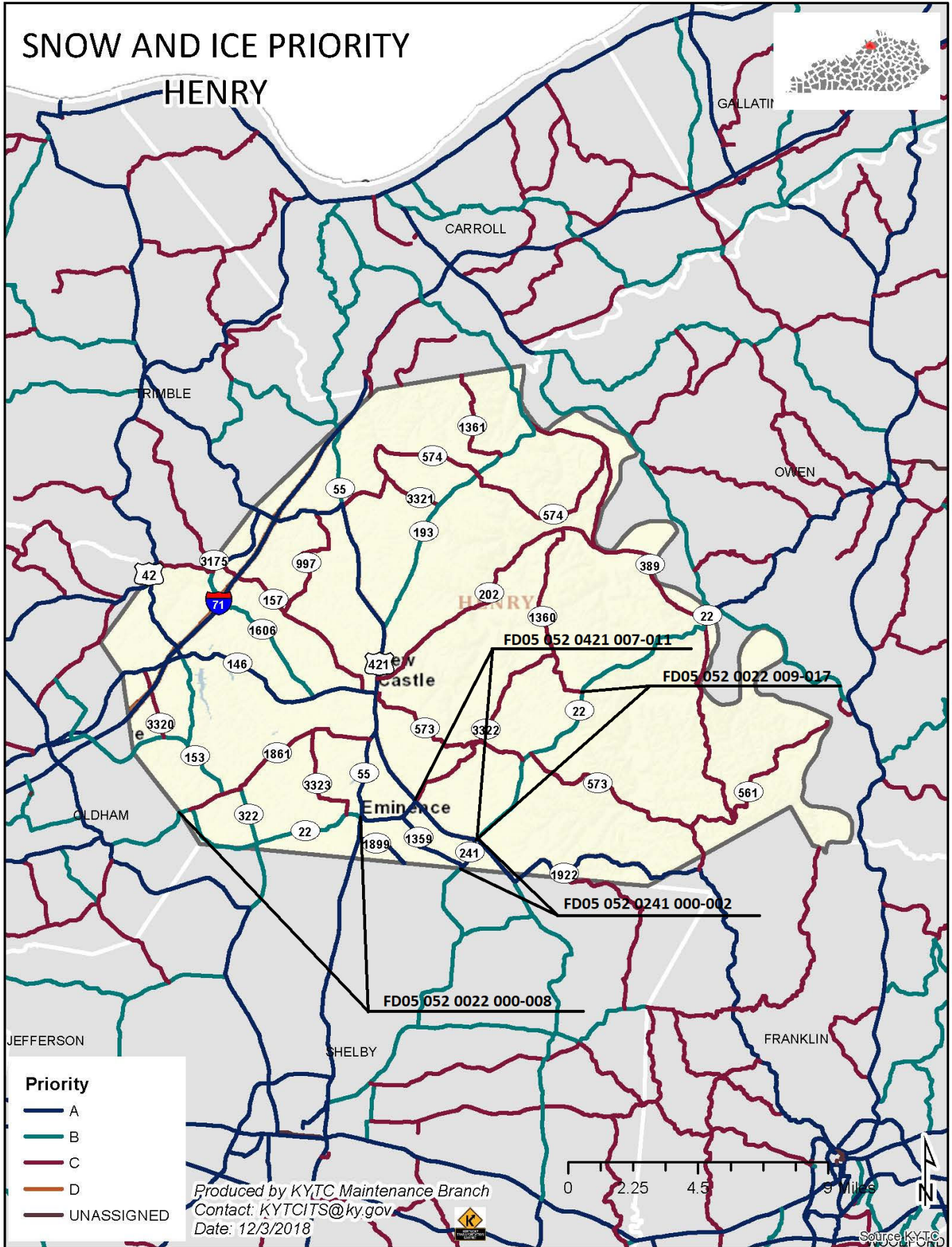

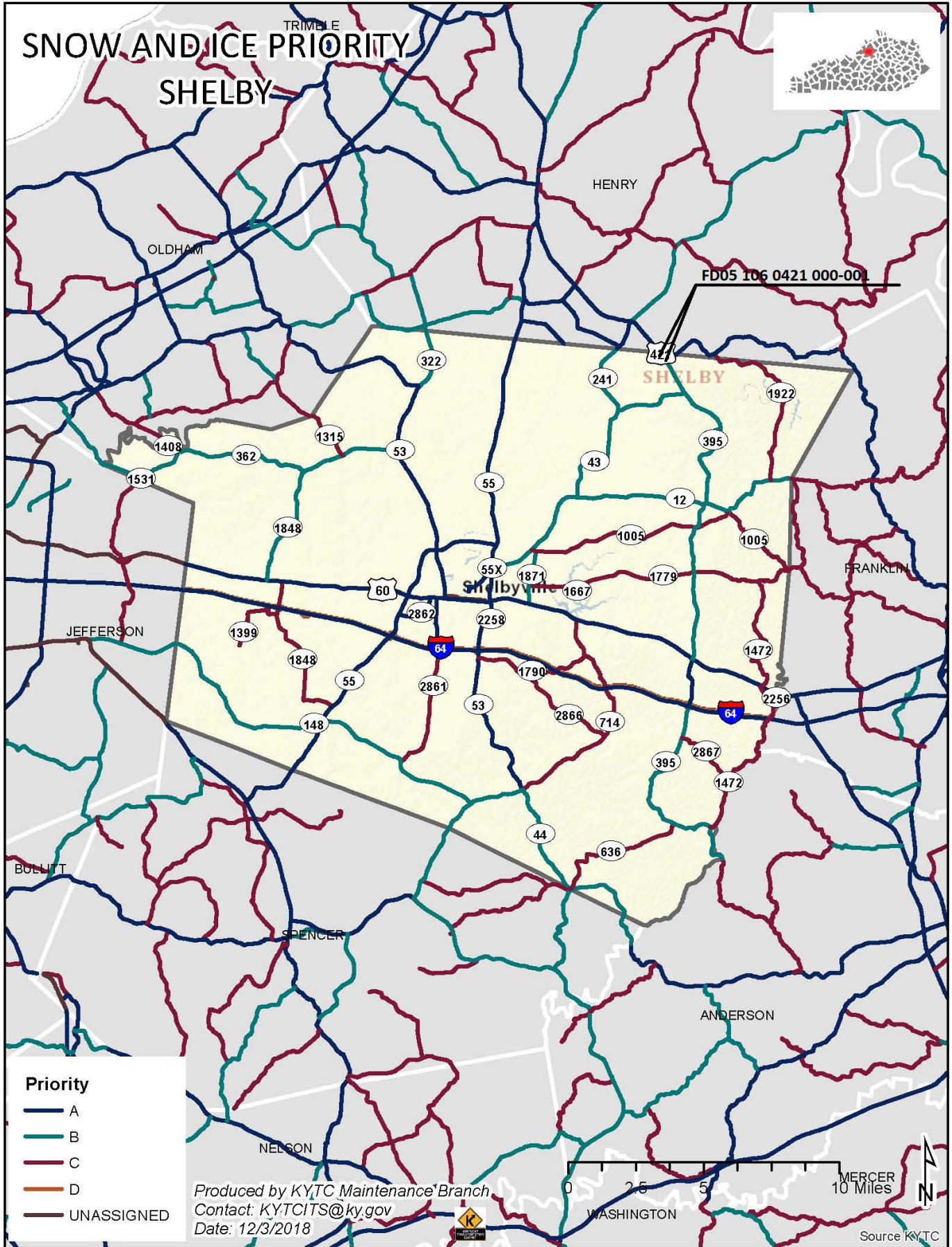

MATERIAL SUMMARY

CONTRACT ID: 192126**121GR19P029 - FD05****MP05200221901**

BALLARDSVILLE ROAD (KY 22) BEGIN AT THE OLDHAM/HENRY COUNTY LINE EXTENDING EAST TO KY 55 ASPHALT RESURFACING, A DISTANCE OF 7.42 MILES.

Project Line No	Bid Code	DESCRIPTION	Quantity	Unit
0005	02562	TEMPORARY SIGNS	370.00	SQFT
0010	02650	MAINTAIN & CONTROL TRAFFIC - (KY 22, 000-008)	1.00	LS
0015	00307	CL2 ASPH SURF 0.38B PG64-22	6,710.00	TON
0020	00190	LEVELING & WEDGING PG64-22	415.00	TON
0025	02676	MOBILIZATION FOR MILL & TEXT - (KY 22, 000-008)	1.00	LS
0030	02677	ASPHALT PAVE MILLING & TEXTURING	715.00	TON
0035	03240	BASE FAILURE REPAIR	2,030.00	SQYD
0040	06514	PAVE STRIPING-PERM PAINT-4 IN	136,000.00	LF
0045	06510	PAVE STRIPING-TEMP PAINT-4 IN	20,000.00	LF
0050	06565	PAVE MARKING-THERMO X-WALK-6 IN	225.00	LF
0055	06544	PAVE STRIPING-THERMO-8 IN W	500.00	LF
0060	06568	PAVE MARKING-THERMO STOP BAR-24IN	240.00	LF
0065	22520EN	PAVE MARKING-THERMO YIELD BAR-36 IN	30.00	LF
0070	06574	PAVE MARKING-THERMO CURV ARROW	6.00	EACH
0075	04895	LOOP SAW SLOT AND FILL	665.00	LF
0080	04830	LOOP WIRE	1,590.00	LF
0085	04850	CABLE-NO. 14/1 PAIR	50.00	LF
0090	04811	ELECTRICAL JUNCTION BOX TYPE B	4.00	EACH
0095	02569	DEMOBILIZATION	1.00	LS
0100	02697	EDGE LINE RUMBLE STRIPS	66,000.00	LF
0105	10030NS	ASPHALT ADJUSTMENT	27,856.00	DOLL
0110	10020NS	FUEL ADJUSTMENT	11,090.00	DOLL
0115	24970EC	ASPHALT MATERIAL FOR TACK NON-TRACKING	36.00	TON
0120	24963ED	LOOP TEST	5.00	EACH
0125	04792	CONDUIT-1 IN	40.00	LF
0130	24900EC	PVC CONDUIT-1 1/4 IN-SCHEDULE 80	65.00	LF
0135	04850	CABLE-NO. 14/1 PAIR	540.00	LF
0140	04820	TRENCHING AND BACKFILLING	65.00	LF
0145	04960	REMOVE AND REPLACE SIDEWALK	3.00	SQYD

MATERIAL SUMMARY

CONTRACT ID: 192126**121GR19P029 - FD05****MP05200221902**

BETHLEHEM ROAD (KY 22) BEGIN AT US 421 EXTENDING EAST TO KY 1360 ASPHALT RESURFACING, A DISTANCE OF 6.87 MILES.

Project Line No	Bid Code	DESCRIPTION	Quantity	Unit
0150	02562	TEMPORARY SIGNS	370.00	SQFT
0155	02650	MAINTAIN & CONTROL TRAFFIC - (KY 22, 009-0017)	1.00	LS
0160	00307	CL2 ASPH SURF 0.38B PG64-22	5,685.00	TON
0165	00190	LEVELING & WEDGING PG64-22	342.00	TON
0170	02676	MOBILIZATION FOR MILL & TEXT	1.00	LS
0175	02677	ASPHALT PAVE MILLING & TEXTURING	135.00	TON
0180	03240	BASE FAILURE REPAIR	470.00	SQYD
0185	06514	PAVE STRIPING-PERM PAINT-4 IN	135,000.00	LF
0190	06510	PAVE STRIPING-TEMP PAINT-4 IN	20,000.00	LF
0195	06568	PAVE MARKING-THERMO STOP BAR-24IN	18.00	LF
0200	02697	EDGELINE RUMBLE STRIPS	66,500.00	LF
0205	24970EC	ASPHALT MATERIAL FOR TACK NON-TRACKING	31.00	TON
0210	02569	DEMOBILIZATION	1.00	LS
0215	10030NS	ASPHALT ADJUSTMENT	23,415.00	DOLL
0220	10020NS	FUEL ADJUSTMENT	9,322.00	DOLL

CONTRACT ID: 192126**121GR19P029 - FD05****MP05202411901**

MAIN STREET (KY 241) BEGIN AT THE SHELBY/HENRY COUNTY LINE EXTENDING NORTH TO US 421 ASPHALT RESURFACING, A DISTANCE OF 1.14 MILES.

Project Line No	Bid Code	DESCRIPTION	Quantity	Unit
0225	02562	TEMPORARY SIGNS	350.00	SQFT
0230	02650	MAINTAIN & CONTROL TRAFFIC - (KY 241)	1.00	LS
0235	00307	CL2 ASPH SURF 0.38B PG64-22	1,030.00	TON
0240	00190	LEVELING & WEDGING PG64-22	32.00	TON
0245	02676	MOBILIZATION FOR MILL & TEXT - (KY 241)	1.00	LS
0250	06514	PAVE STRIPING-PERM PAINT-4 IN	23,500.00	LF
0255	02677	ASPHALT PAVE MILLING & TEXTURING	1,030.00	TON
0260	06510	PAVE STRIPING-TEMP PAINT-4 IN	27,000.00	LF
0265	06568	PAVE MARKING-THERMO STOP BAR-24IN	72.00	LF
0270	06565	PAVE MARKING-THERMO X-WALK-6 IN	70.00	LF
0275	24970EC	ASPHALT MATERIAL FOR TACK NON-TRACKING	5.00	TON
0280	02569	DEMOBILIZATION	1.00	LS

MATERIAL SUMMARY

CONTRACT ID: 192126**121GR19P029 - FD05****MP05204211901**

NEW CASTLE HIGHWAY (US 421) BEGIN AT KY 22 EXTENDING NORTH TO KY 3322/KY 22 ASPHALT RESURFACING, A DISTANCE OF 2.57 MILES.

Project Line No	Bid Code	DESCRIPTION	Quantity	Unit
0285	02562	TEMPORARY SIGNS	290.00	SQFT
0290	02650	MAINTAIN & CONTROL TRAFFIC - (US 421 007-011)	1.00	LS
0295	00307	CL2 ASPH SURF 0.38B PG64-22	2,695.00	TON
0300	24970EC	ASPHALT MATERIAL FOR TACK NON-TRACKING	14.00	TON
0305	00190	LEVELING & WEDGING PG64-22	232.00	TON
0310	02676	MOBILIZATION FOR MILL & TEXT - (US 421, 007-001)	1.00	LS
0315	02677	ASPHALT PAVE MILLING & TEXTURING	2,695.00	TON
0320	06514	PAVE STRIPING-PERM PAINT-4 IN	56,000.00	LF
0325	06510	PAVE STRIPING-TEMP PAINT-4 IN	56,000.00	LF
0330	06568	PAVE MARKING-THERMO STOP BAR-24IN	96.00	LF
0335	06565	PAVE MARKING-THERMO X-WALK-6 IN	220.00	LF
0340	20458ES403	CENTERLINE RUMBLE STRIPS	10,700.00	LF
0345	02696	SHOULDER RUMBLE STRIPS	21,400.00	LF
0350	02569	DEMOBILIZATION	1.00	LS

CONTRACT ID: 192126**121GR19P029 - FD05****MP10604211901**

BALD KNOB ROAD (US 421) BEGIN AT THE HENRY/SHELBY COUNTY LINE EXTENDING NORTH TO THE SHELBY/HENRY ASPHALT RESURFACING, A DISTANCE OF .79 MILES.

Project Line No	Bid Code	DESCRIPTION	Quantity	Unit
0355	02562	TEMPORARY SIGNS	170.00	SQFT
0360	02650	MAINTAIN & CONTROL TRAFFIC - (US 421, 000-001)	1.00	LS
0365	00307	CL2 ASPH SURF 0.38B PG64-22	730.00	TON
0370	24970EC	ASPHALT MATERIAL FOR TACK NON-TRACKING	4.00	TON
0375	00190	LEVELING & WEDGING PG64-22	46.00	TON
0380	02676	MOBILIZATION FOR MILL & TEXT - (US 421, 000-001)	1.00	LS
0385	02677	ASPHALT PAVE MILLING & TEXTURING	25.00	TON
0390	03240	BASE FAILURE REPAIR	55.00	SQYD
0395	06514	PAVE STRIPING-PERM PAINT-4 IN	17,000.00	LF
0400	06510	PAVE STRIPING-TEMP PAINT-4 IN	1,000.00	LF
0405	20458ES403	CENTERLINE RUMBLE STRIPS	4,171.00	LF
0410	02697	EDGELINE RUMBLE STRIPS	8,342.00	LF
0415	02569	DEMOBILIZATION	1.00	LS

**HENRY COUNTY
TRAFFIC LOOP SUMMARY
FD05 052 0022 000-008
LOOP SUMMARY FOR ASPHALT PAVEMENT**

INTERSECTION	SAW, SLOT AND FILL LF	LOOP WIRE LF	PVC			CONDUIT NO. 14 LF	JUNCTION TYPE B EA	BORE & JACK CONDUIT LF	ROADWAY LF	OPEN CUT LF	REMOVE AND REPLACE SIDEWALK SQ YD	Trenching and Backfilling LF	Loop Test EA	NOTES
			CONDUIT 1 INCH LF	CONDUIT 1 1/4 INCH LF	CONDUIT 2 INCH LF									
KY 22	255	635	10	25	0	60	1	0	0	1	25	2	2 6X30 STOP BAR LOOP	
CVS	130	315	10	20	0	190	1	0	0	0	20	1	6X30 STOP BAR LOOP	
55 North	150	325	10	10	0	260	1	0	0	1	10	1	6X30 STOP BAR LOOP	
55 South	130	315	10	10	0	30	1	0	0	1	10	1	6X30 STOP BAR LOOP	
Total	665	1590	40	65	0	540	4	0	0	3	65	5		

- Quantities are for estimating purposes only. The Contractor shall field measure and inspect items to verify quantities.
- 2 - 1 1/4 inch conduits may be used in place of 2" conduit. Field verify conduit to match existing facilities/tie-in to poles/cabinets. specifications Only replace existing conduit if damaged.

Grand Total	665	1590	40	65	0	540	4	0	0	3	65	5
--------------------	------------	-------------	-----------	-----------	----------	------------	----------	----------	----------	----------	-----------	----------

**Base Failure
 Repair Summary
 FD05 052 0022 000-008**

Lane	Milepoint	Length	Width	Total
				2030
				SQYD
WB	0	150	7	116.667
EB	0.135	300	7	233.333
WB	0.159	90	8	80.000
WB	0.389	125	8	111.111
WB	0.5	65	6	43.333
WB	0.588	375	6	250.000
WB	0.983	49	6	32.667
WB	1.03	34	7	26.444
EB	1.493	185	7	143.889
WB	1.937	32	6	21.333
WB	2.001	72	7	56.000
EB	2.399	50	7	38.889
WB	2.452	30	6	20.000
WB	2.595	82	6	54.667
WB	2.611	56	6	37.333
WB	2.692	90	6	60.000
WB	2.706	30	6	20.000
EB	2.85	50	7	38.889
WB	2.876	80	6	53.333
EB	2.887	85	7	66.111
WB	2.913	80	6	53.333
WB	3.17	105	7	81.667
EB	3.293	105	7	81.667
EB	3.866	60	6	40.000
WB	4.331	150	9	150.000
EB	4.823	45	6	30.000
EB	4.933	80	6	53.333
WB	5.065	45	7	35.000

HENRY COUNTY
FD05 052 0022 000-008
TYPICAL SECTION
MILEPOINTS 0.000 to 6.822

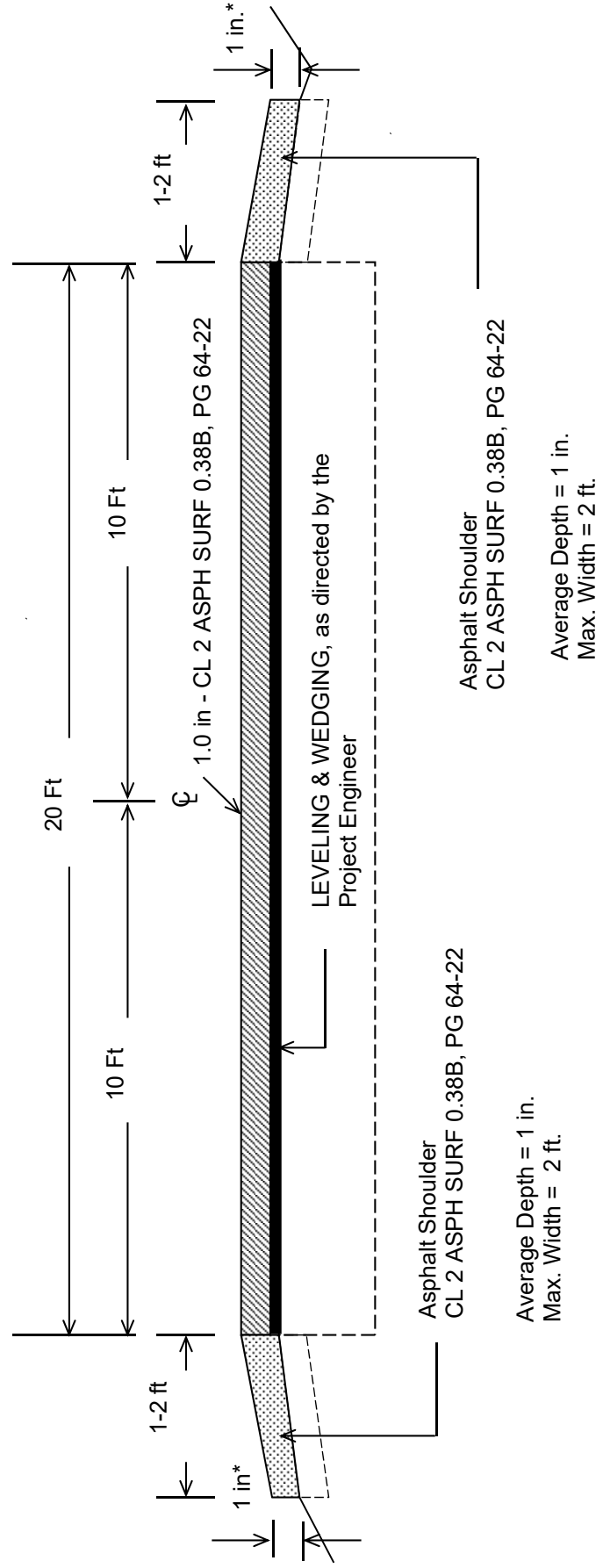

***Where Existing Site Conditions Permit
Edgeline Rumbles from MP's 0.000 to 6.211**

HENRY COUNTY
FD05 052 0022 000-008
TYPICAL SECTION
MILEPOINTS 6.822 to 7.420

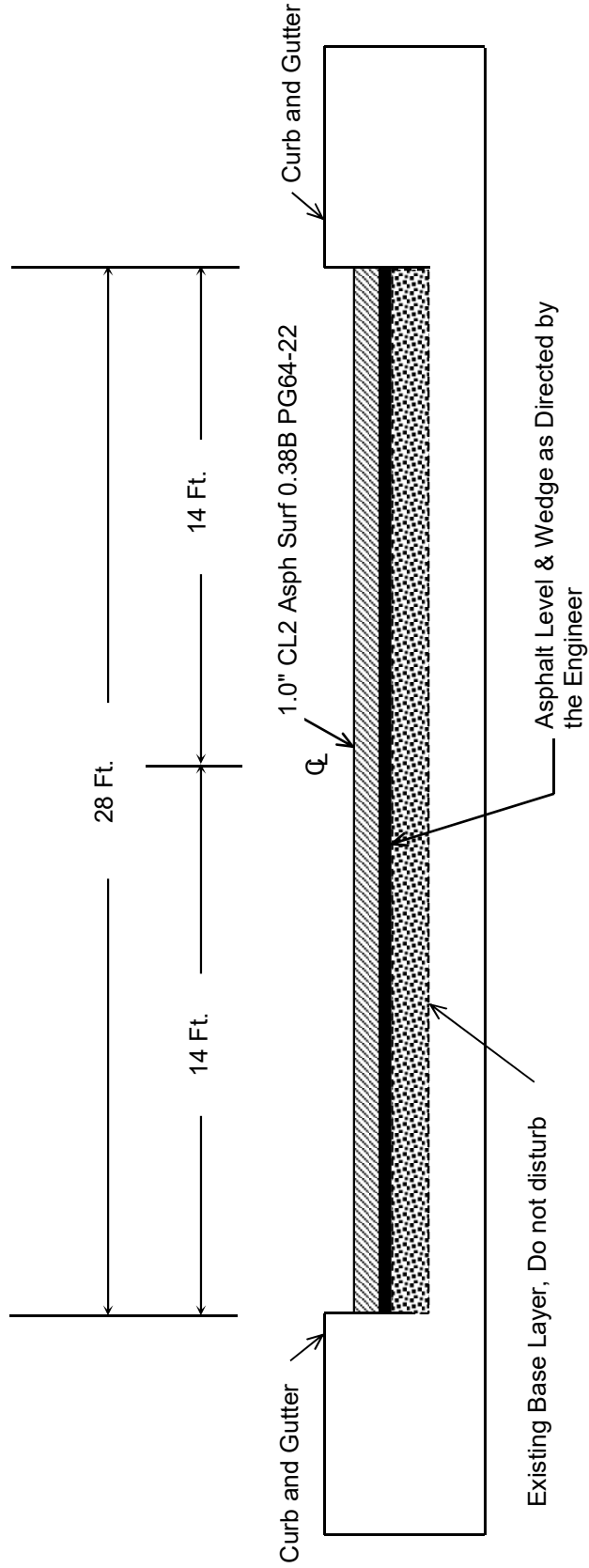

Asphalt Milling and Texturing
Average Depth = 1 Inches
Max Width = 28 Ft.

HENRY COUNTY
FD05 052 0022 009-017
TYPICAL SECTION
MILEPOINTS 9.712 to 16.584

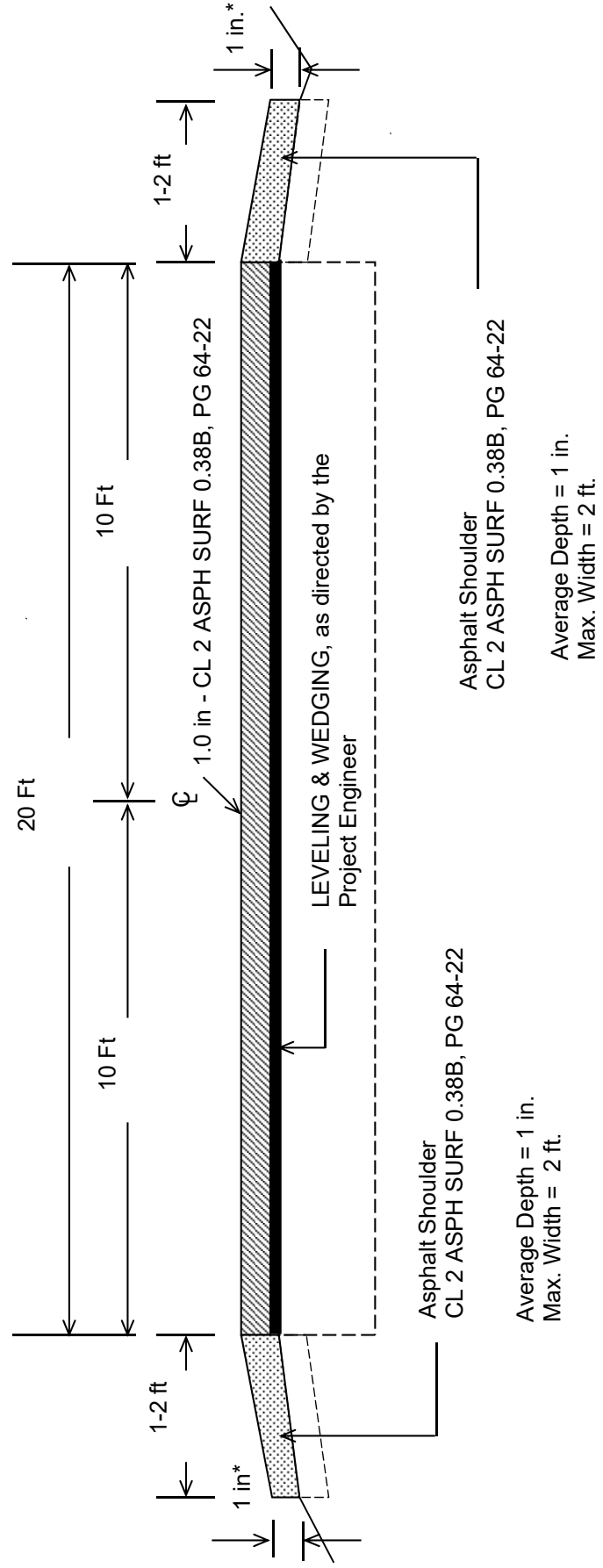

***Where Existing Site Conditions Permit
Edgeline Rumbles MP's 9.970 to 13.270 and MP's 13.601 to 16.584**

HENRY COUNTY
FD05 052 0241 000-002
TYPICAL SECTION
MILEPOINTS 0-0.081 & 0.166-1.147

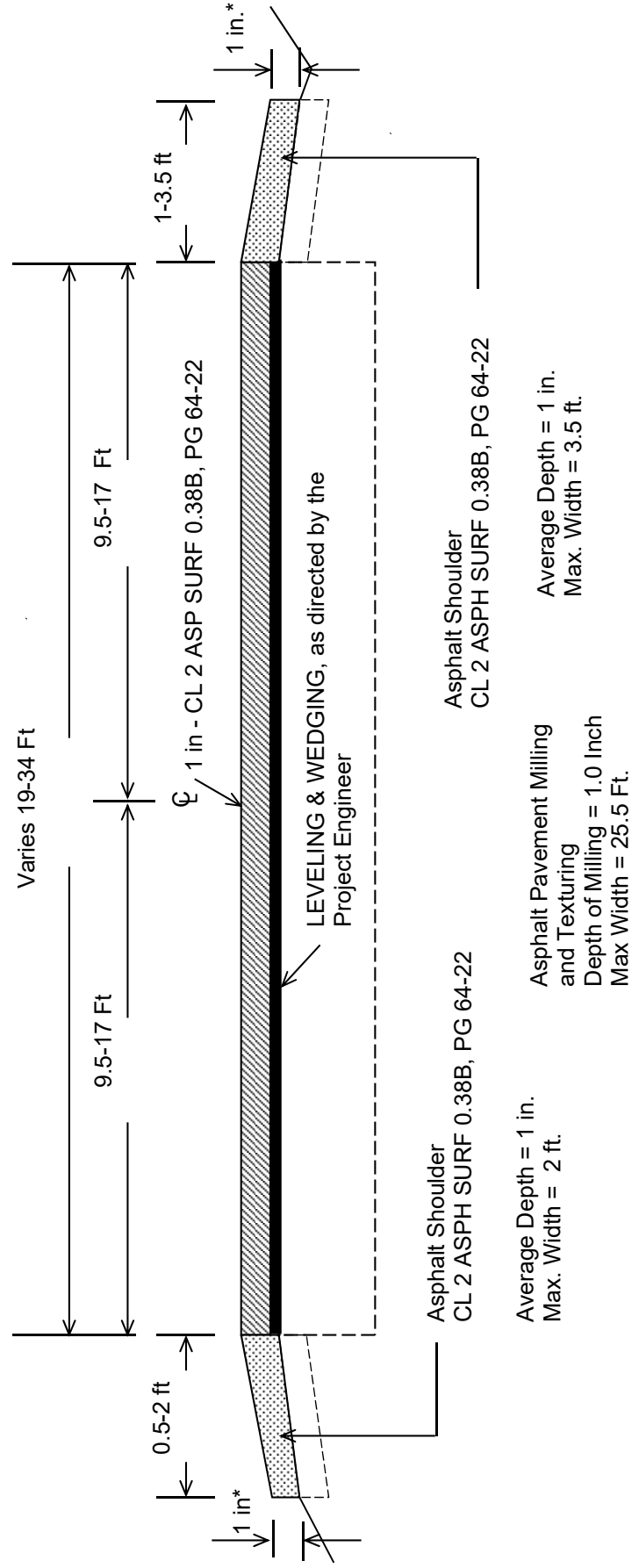

***Where Existing Site Conditions Permit**

HENRY COUNTY
FD05 052 0241 000-002
TYPICAL SECTION
MILEPOINTS 0.081 to 0.166

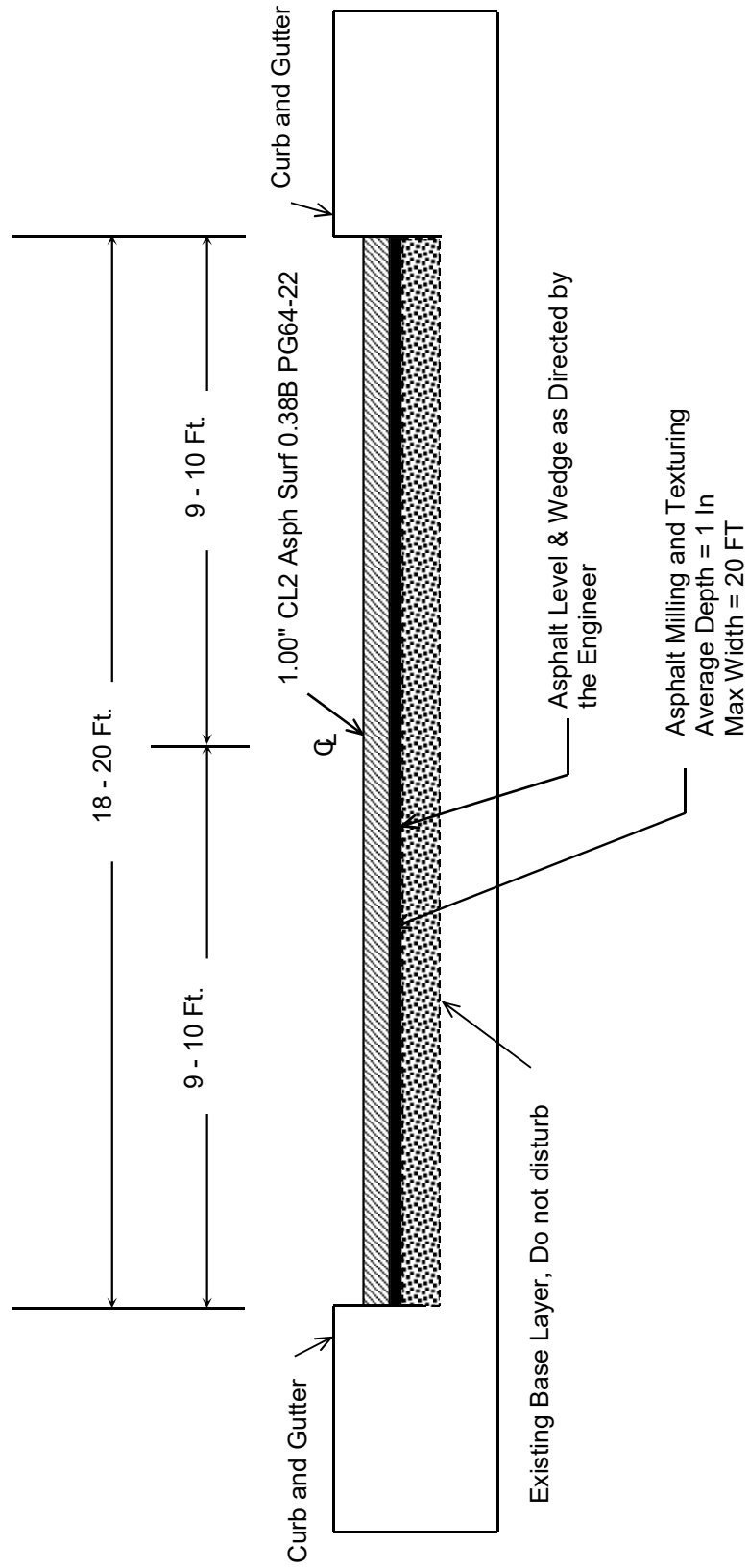

HENRY COUNTY
FD05 052 0421 007-011
TYPICAL SECTION
MILEPOINTS 7.854 - 10.426

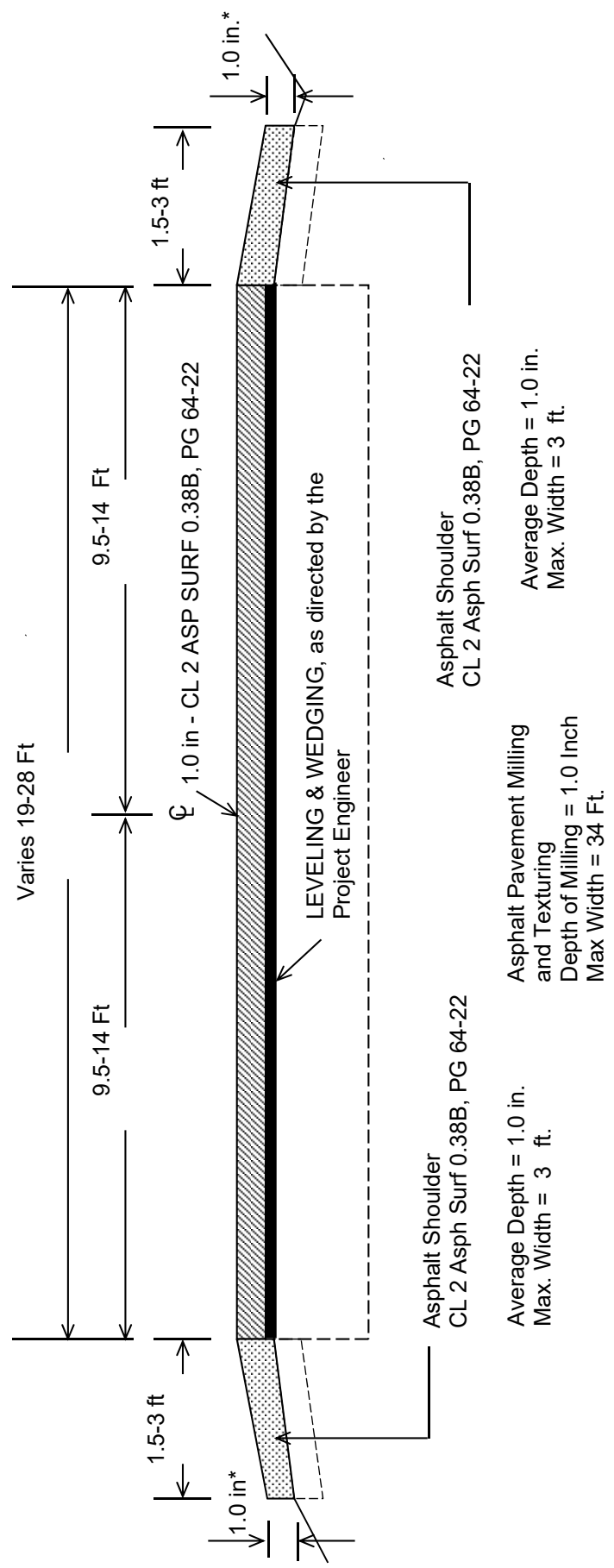

***Where Existing Site Conditions Permit**

**SHELBY COUNTY
FD05 106 0421 000-001
TYPICAL SECTION
MILEPOINTS 0.00 to 0.79**

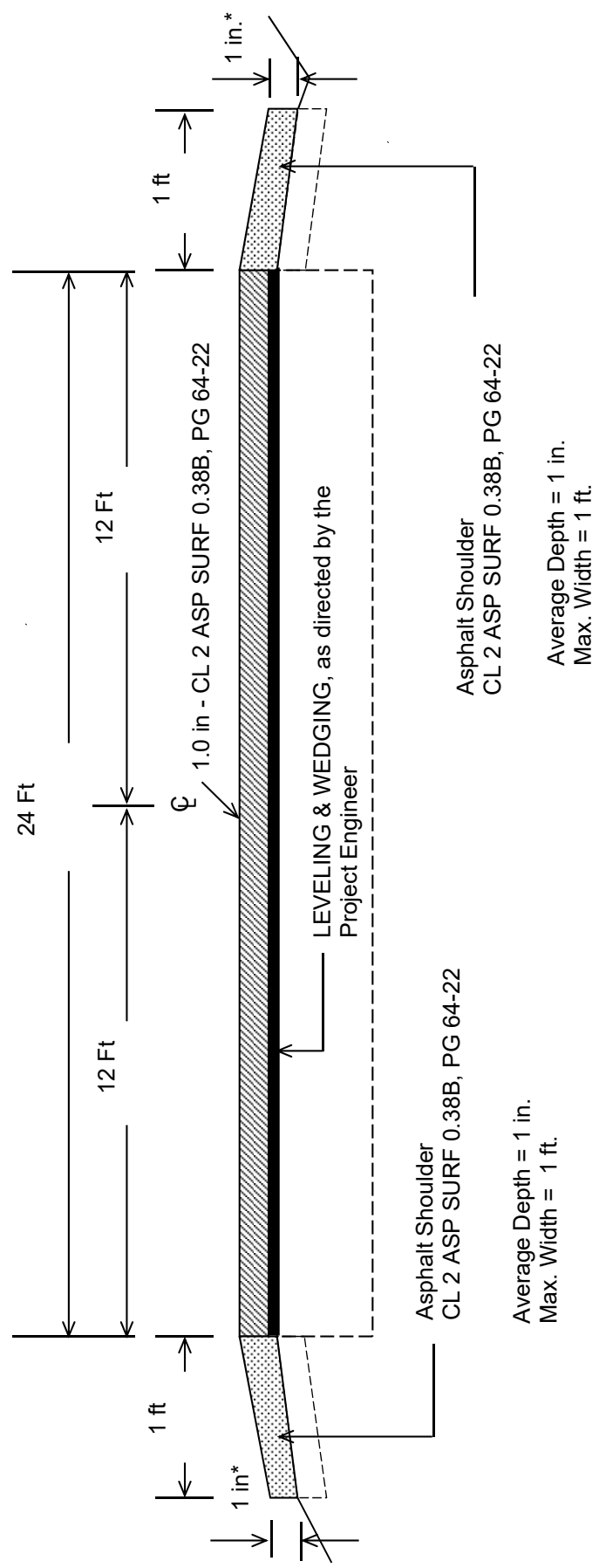

***Where Existing Site Conditions Permit**

BRIDGE DETAIL FOR PAVING PROJECT

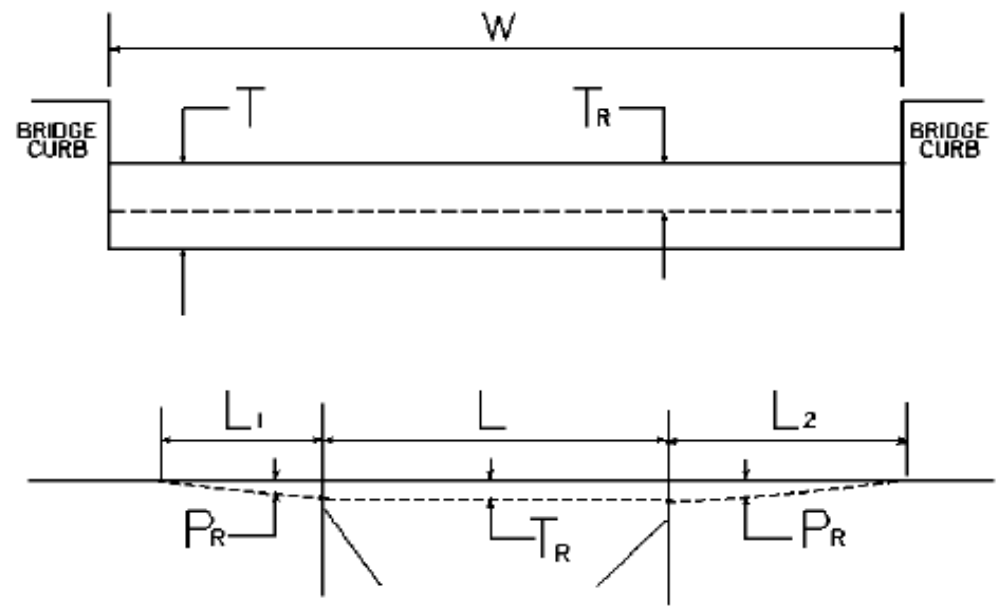

W = bridge width curb to curb
 T = thickness of existing asphalt overlay
 L = length of bridge
 L_1 & L_2 = length of approach pavement to be removed
 T_R = thickness to be removed and replaced on bridge
 P_R = thickness to be removed and replaced on pavement
 Note: L_1 & L_2 lengths shall be determined by using a transition rate of 100 ft/in of thickness

Route	Bridge No.	MP	W (ft)	T (in)	L ₁ (ft)	L ₂ (ft)	T _R (in)	L (ft)	P _R (in)
KY 22	B00025N	1.236	27.000	0.000	100.000	100.000	0.000	36.000	1.000

PART II
SPECIFICATIONS AND STANDARD DRAWINGS

SPECIFICATIONS REFERENCE

Any reference in the plans or proposal to previous editions of the *Standard Specifications for Road and Bridge Construction* and *Standard Drawings* are superseded by *Standard Specifications for Road and Bridge Construction, Edition of 2012* and *Standard Drawings, Edition of 2016*.

SUPPLEMENTAL SPECIFICATIONS

The contractor shall use the Supplemental Specifications that are effective at the time of letting.
The Supplemental Specifications can be found at the following link:

<http://transportation.ky.gov/Construction/Pages/Kentucky-Standard-Specifications.aspx>

2016 KENTUCKY STANDARD DRAWINGS

CURVE WIDENING AND SUPERELEVATION TRANSITIONS	RGS-001-07
SUPERELEVATION FOR MULTILANE PAVEMENT	RGS-002-06
MISCELLANEOUS STANDARDS	RGX-001-06
APPROACHES, ENTRANCES, AND MAIL BOX TURNOUT	RPM-110-07
CENTERLINE RUMBLE STRIPS	TPM-150-02
CENTERLINE RUMBLE STRIP 4 INCH STRIPING	TPM-155-02
SHOULDER AND EDGE LINE RUMBLE STRIP DETAILS	TPM-165
LANE CLOSURE TWO-LANE HIGHWAY	TTC-100-04
SHOULDER CLOSURE	TTC-135-02
PAVEMENT CONDITION WARNING SIGNS	TTD-125-02
MOBILE OPERATION FOR PAINT STRIPING CASE I	TTS-100-02
MOBILE OPERATION FOR PAINT STRIPING CASE II	TTS-105-02

COUNTY OF	TITLING	SHEET NO.

PLAN VIEW

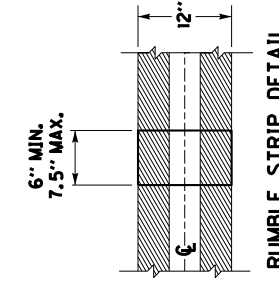
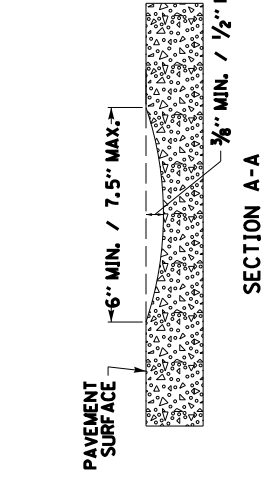
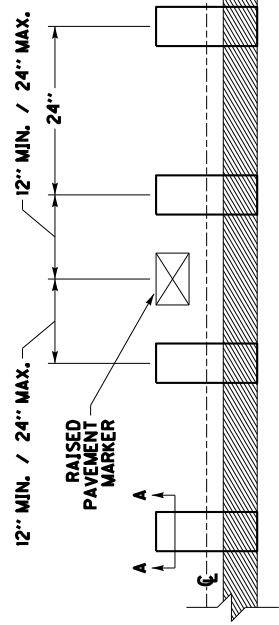
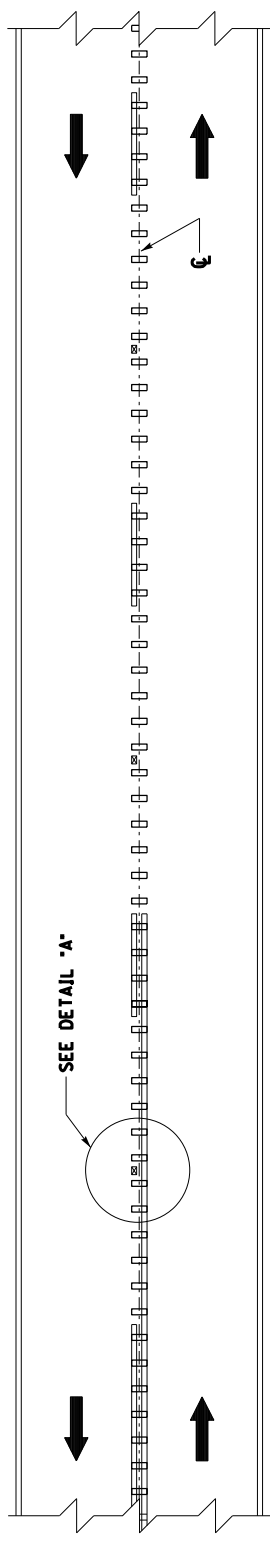

DETAIL 'A'

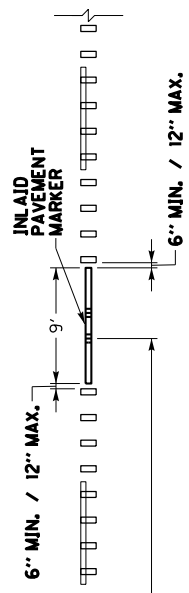
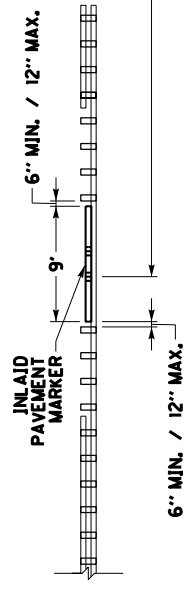

DETAIL FOR CENTERLINE RUMBLE STRIPS WITH INLAID PAVEMENT MARKERS

NOTES

1. DISTANCES SHOWN ARE APPROXIMATE. MAINTAIN RUMBLE STRIP DIMENSIONS AND SPACING AS MUCH AS POSSIBLE.
2. CENTERLINE RUMBLE STRIPS SHALL BE INSTALLED IN LINE WITH THE CENTER OF THE ROADWAY AS MUCH AS POSSIBLE.
3. DISCONTINUE CENTERLINE RUMBLE STRIPS AT LEAST 12" BEFORE AND AFTER THE CENTER OF EACH RAISED PAVEMENT MARKER, AND AT LEAST 6" BEFORE AND AFTER THE GROOVE FOR EACH INLAID PAVEMENT MARKER. INSTALL AS MANY RUMBLE STRIPS AS POSSIBLE BETWEEN ADJACENT PAVEMENT MARKERS WHILE MAINTAINING THE 24" CYCLE.
4. DO NOT INSTALL CENTERLINE RUMBLE STRIPS IN AREAS INDICATED ON TPM-150.
5. CENTERLINE RUMBLE STRIPS SHOULD BE OMITTED WHERE THE POSTED SPEED LIMIT IS 45 MPH OR LESS, OR WHERE LANE WIDTHS ARE LESS THAN 11 FT.

BID ITEM AND UNIT TO BID
 CENTERLINE RUMBLE STRIPS

LF

DRAWING NOT TO SCALE
 USE WITH CUR. STD. DWG.
 TPM-150

KENTUCKY
 DEPARTMENT OF HIGHWAYS
 CENTERLINE
 RUMBLE STRIPS
 4 INCH STRIPING

SUBMITTED: *B. [Signature]*
 JL-23-16
 DATE
 003

COUNTY OF	SHEET NO.
TIERING	

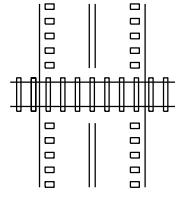
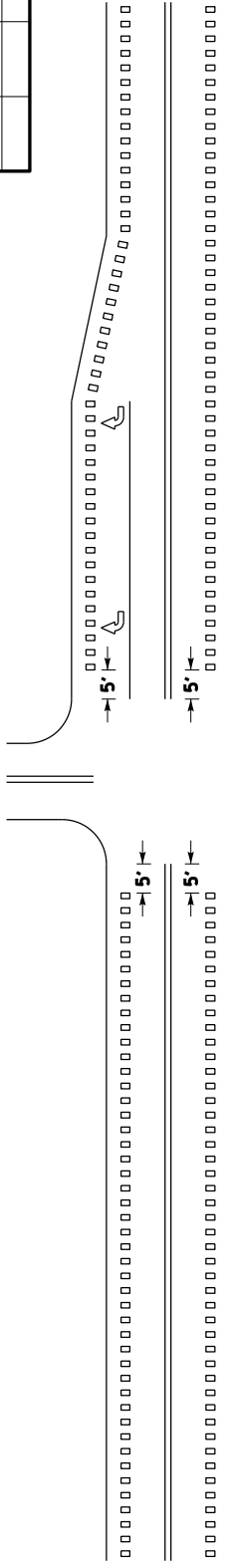

HIGHWAY-RAIL GRADE CROSSINGS ③

INTERSECTIONS WITH OR WITHOUT RIGHT TURN LANES ①

MARKED CROSSWALK ②

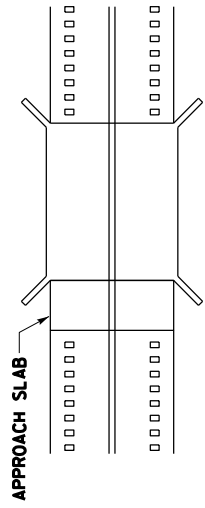

BRIDGE DECK/APPROACH SLAB ④

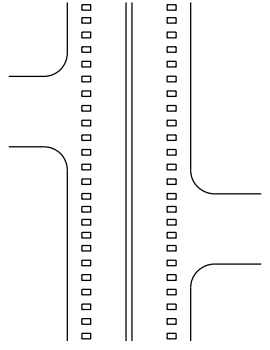

DRIVEWAYS/MINOR COMMERCIAL ENTRANCES ⑤

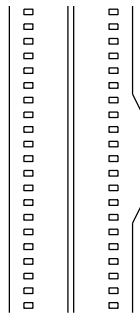

MAILBOX TURNOUTS ⑥

~ NOTES ~

- ① RUMBLE STRIPS SHALL BE OMITTED THROUGH MAJOR INTERSECTIONS WITH, OR WITHOUT, RIGHT-TURN LANES. OMIT RUMBLE STRIPS APPROXIMATELY 5' IN ADVANCE OF THE AREA WHERE EDGELINE PAVEMENT MARKINGS HAVE BEEN OMITTED (NORMALLY WHERE SIDE STREET RADIUS INTERSECTS MAINLINE).
- ② RUMBLE STRIPS SHALL NOT BE INSTALLED THROUGH MARKED CROSSWALKS. OMIT RUMBLE STRIPS APPROXIMATELY 5' IN ADVANCE OF MARKED CROSSWALKS.
- ③ RUMBLE STRIPS SHALL NOT BE INSTALLED ACROSS HIGHWAY-RAIL GRADE CROSSINGS.
- ④ RUMBLE STRIPS SHALL NOT BE INSTALLED ON BRIDGE DECKS OR APPROACH SLABS.
- ⑤ RUMBLE STRIPS SHALL BE INSTALLED THROUGH DRIVEWAYS & MINOR COMMERCIAL ENTRANCES.
- ⑥ RUMBLE STRIPS SHALL BE INSTALLED THROUGH MAILBOX TURNOUTS.
7. RUMBLE STRIPS SHOULD BE OMITTED WHERE THE POSTED SPEED LIMIT IS 45 MPH OR LESS.

DRAWING NOT TO SCALE

USE WITH SEP1A 006, 007, AND 008

KENTUCKY
DEPARTMENT OF HIGHWAYS
SHOULDER & EDGELINE
RUMBLE STRIP DETAILS

Submitted: *B. [Signature]*
DATE: 11-23-16
005

BID ITEMS AND UNIT TO BID
EDGELINE RUMBLE STRIPS
SHOULDER RUMBLE STRIPS

LF
LF

COUNTY OF	TITLING	SHEET NO.
		005

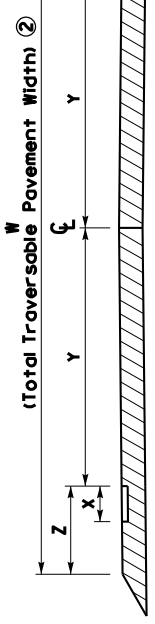

PAVEMENT CROSS-SECTION

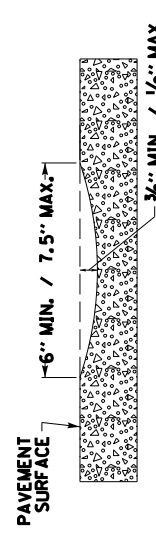
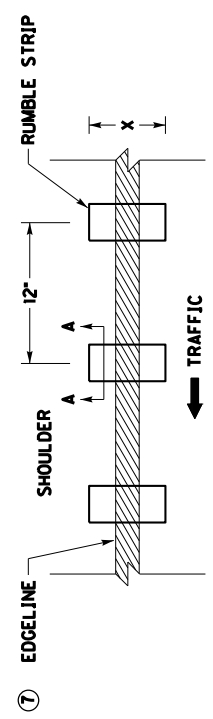

PAVEMENT WIDTH (W) ②	RUMBLE LENGTH (X) ⑥	ELRS ONLY		CLRS & ELRS	
		LANE WIDTH (Y) ③	SHOULDER WIDTH (Z) ④	LANE WIDTH (Y) ③	SHOULDER WIDTH (Z) ④
20'	8"	9'	1'	N/A	N/A
21'	8"	9.5'	1'	N/A	N/A
22'	8"	10'	1'	N/A	N/A
23'	8"	10'	1.5'	N/A	N/A
24'	8"	10.5'	1.5'	N/A	N/A
25'	8"	N/A	N/A	11'	1.5'
26'	8"	N/A	N/A	11'	2'
27'	8"	N/A	N/A	11.5'	2'
28'	8"	N/A	N/A	12'	2'
29'	8"	N/A	N/A	12'	2.5'
30'	8"	N/A	N/A	12'	3'
31'	8"	N/A	N/A	12'	3.5'
32'	8"	N/A	N/A	12'	4'
33'	8"	N/A	N/A	12'	4.5'

NOTES

1. EDGELINE RUMBLE STRIPS SHOULD BE INSTALLED ACCORDING TO THE DIMENSIONS PROPOSED ABOVE UNLESS THERE IS AN ENGINEERING BASIS THAT SUPPORTS A CHANGE IN DIMENSION. FOR EXAMPLE, IF THE EXISTING LANE WIDTH IS NARROWER THAN THE LANE WIDTH PROPOSED IN THIS DRAWING AND THE EXISTING SHOULDER PAVEMENT DEPTH IS NOT SUITABLE TO BE CONVERTED INTO A PORTION OF THE PROPOSED LANE WIDTH, THEN THE EXISTING LANE WIDTH SHOULD BE USED INSTEAD OF THE WIDTH PROPOSED IN THIS DRAWING.
2. PAVEMENT WIDTH (W) IS THE TOTAL WIDTH OF TRAVERSABLE PAVEMENT. DO NOT INCLUDE THE WIDTH OF ANY NON-TRAVERSABLE PAVEMENT, SUCH AS PAVEMENT WEDGES, WHEN MEASURING THE PAVEMENT WIDTH (W).
3. LANE WIDTH (Y) TO BE MEASURED FROM CENTER OF ROAD TO LANE SIDE EDGE OF RUMBLE STRIP.
4. PAVED SHOULDER WIDTH (Z) TO BE MEASURED FROM LANE SIDE EDGE OF RUMBLE STRIP TO OUTSIDE EDGE OF TRAVERSABLE PAVEMENT.
5. DISTANCES SHOWN ARE APPROXIMATE. MAINTAIN RUMBLE STRIP DIMENSIONS AND SPACING AS MUCH AS POSSIBLE. IF THE TYPICAL SECTION SHOWS A LANE WIDTH (Y) AND/OR SHOULDER WIDTH (Z) THAT DIFFERS FROM THE WIDTHS LISTED IN THIS DRAWING, THE ENGINEER SHALL DETERMINE THE LANE WIDTH (Y) AND/OR SHOULDER WIDTH (Z) AT THE TIME OF CONSTRUCTION.
NOTE: CENTERLINE RUMBLE STRIPS SHOULD BE OMITTED WHEN THE LANE WIDTH (Y) IS LESS THAN 11 FT.
6. RUMBLE LENGTH (X) MAY BE MODIFIED AS THE ENGINEER DIRECTS. IF THE SHOULDER WIDTH (Z) IS EQUAL TO OR LESS THAN THE PROPOSED RUMBLE LENGTH (X).
7. PLACE THE EDGELINE MARKING IN THE CENTER OF THE RUMBLE STRIP.
8. EDGELINE RUMBLE STRIPS SHOULD BE OMITTED WHERE THE POSTED SPEED LIMIT IS 45 MPH OR LESS.

BID ITEM AND UNIT TO BID
EDGELINE RUMBLE STRIPS

LF

DRAWING NOT TO SCALE

USE WITH SEPIA 005

KENTUCKY DEPARTMENT OF HIGHWAYS
EDGELINE RUMBLE STRIP DETAILS TWO LANE ROADWAYS
SUBMITTED: <i>B. [Signature]</i> JL-23-16 DATE
006

PART III

EMPLOYMENT, WAGE AND RECORD REQUIREMENTS

**TRANSPORTATION CABINET
DEPARTMENT OF HIGHWAYS**

**LABOR AND WAGE REQUIREMENTS
APPLICABLE TO OTHER THAN FEDERAL-AID SYSTEM PROJECTS**

- I. Application
- II. Nondiscrimination of Employees (KRS 344)

I. APPLICATION

1. These contract provisions shall apply to all work performed on the contract by the contractor with his own organization and with the assistance of workmen under his immediate superintendence and to all work performed on the contract by piecework, station work or by subcontract. The contractor's organization shall be construed to include only workmen employed and paid directly by the contractor and equipment owned or rented by him, with or without operators.

2. The contractor shall insert in each of his subcontracts all of the stipulations contained in these Required Provisions and such other stipulations as may be required.

3. A breach of any of the stipulations contained in these Required Provisions may be grounds for termination of the contract.

3. If the contractor is in control of apprenticeship or other training or retraining, including on-the-job training programs, he shall not discriminate against an individual because of his race, color, religion, national origin, sex, disability or age forty (40) and over, in admission to, or employment in any program established to provide apprenticeship or other training.

4. The contractor will send to each labor union or representative of workers with which he has a collective bargaining agreement or other contract or understanding, a notice to be provided advising the said labor union or workers' representative of the contractor's commitments under this section, and shall post copies of the notice in conspicuous places available to employees and applicants for employment. The contractor will take such action with respect to any subcontract or purchase order as the administrating agency may direct as a means of enforcing such provisions, including sanctions for non-compliance.

Revised: January 25, 2017

II. NONDISCRIMINATION OF EMPLOYEES

**AN ACT OF THE KENTUCKY
GENERAL ASSEMBLY TO PREVENT
DISCRIMINATION IN EMPLOYMENT
KRS CHAPTER 344
EFFECTIVE JUNE 16, 1972**

The contract on this project, in accordance with KRS Chapter 344, provides that during the performance of this contract, the contractor agrees as follows:

1. The contractor shall not fail or refuse to hire, or shall not discharge any individual, or otherwise discriminate against an individual with respect to his compensation, terms, conditions, or privileges of employment, because of such individual's race, color, religion, national origin, sex, disability or age (forty and above); or limit, segregate, or classify his employees in any way which would deprive or tend to deprive an individual of employment opportunities or otherwise adversely affect his status as an employee, because of such individual's race, color, religion, national origin, sex, disability or age forty (40) and over. The contractor agrees to post in conspicuous places, available to employees and applicants for employment, notices to be provided setting forth the provisions of this nondiscrimination clause.

2. The contractor shall not print or publish or cause to be printed or published a notice or advertisement relating to employment by such an employer or membership in or any classification or referral for employment by the employment agency, indicating any preference, limitation, specification, or discrimination, based on race, color, religion, national origin, sex, or age forty (40) and over, or because the person is a qualified individual with a disability, except that such a notice or advertisement may indicate a preference, limitation, or specification based on religion, national origin, sex, or age forty (40) and over, or because the person is a qualified individual with a disability, when religion, national origin, sex, or age forty (40) and over, or because the person is a qualified individual with a disability, is a bona fide occupational qualification for employment.

EXECUTIVE BRANCH CODE OF ETHICS

In the 1992 regular legislative session, the General Assembly passed and Governor Brereton Jones signed Senate Bill 63 (codified as KRS 11A), the Executive Branch Code of Ethics, which states, in part:

KRS 11A.040 (7) provides:

No present or former public servant shall, within six (6) months following termination of his office or employment, accept employment, compensation, or other economic benefit from any person or business that contracts or does business with, or is regulated by, the state in matters in which he was directly involved during the last thirty-six (36) months of his tenure. This provision shall not prohibit an individual from returning to the same business, firm, occupation, or profession in which he was involved prior to taking office or beginning his term of employment, or for which he received, prior to his state employment, a professional degree or license, provided that, for a period of six (6) months, he personally refrains from working on any matter in which he was directly involved during the last thirty-six (36) months of his tenure in state government. This subsection shall not prohibit the performance of ministerial functions, including but not limited to filing tax returns, filing applications for permits or licenses, or filing incorporation papers, nor shall it prohibit the former officer or public servant from receiving public funds disbursed through entitlement programs.

KRS 11A.040 (9) states:

A former public servant shall not represent a person or business before a state agency in a matter in which the former public servant was directly involved during the last thirty-six (36) months of his tenure, for a period of one (1) year after the latter of:

- a) The date of leaving office or termination of employment; or
- b) The date the term of office expires to which the public servant was elected.

This law is intended to promote public confidence in the integrity of state government and to declare as public policy the idea that state employees should view their work as a public trust and not as a way to obtain private benefits.

If you have worked for the executive branch of state government within the past six months, you may be subject to the law's prohibitions. The law's applicability may be different if you hold elected office or are contemplating representation of another before a state agency.

Also, if you are affiliated with a firm which does business with the state and which employs former state executive-branch employees, you should be aware that the law may apply to them.

In case of doubt, the law permits you to request an advisory opinion from the Executive Branch Ethics Commission, 3 Fountain Place, Frankfort, Kentucky 40601; telephone (502) 564-7954.

Revised: January 27, 2017

Kentucky Equal Employment Opportunity Act of 1978

The requirements of the Kentucky Equal Employment Opportunity Act of 1978 (KRS 45.560-45.640) shall apply to this Contract. The apparent low Bidder will be required to submit EEO forms to the Division of Construction Procurement, which will then forward to the Finance and Administration Cabinet for review and approval. No award will become effective until all forms are submitted and EEO/CC has certified compliance. The required EEO forms are as follows:

- EEO-1: Employer Information Report
- Affidavit of Intent to Comply
- Employee Data Sheet
- Subcontractor Report

These forms are available on the Finance and Administration's web page under ***Vendor Information, Standard Attachments and General Terms*** at the following address:
<https://www.eProcurement.ky.gov>.

Bidders currently certified as being in compliance by the Finance and Administration Cabinet may submit a copy of their approval letter in lieu of the referenced EEO forms.

For questions or assistance please contact the Finance and Administration Cabinet by email at **finance.contractcompliance@ky.gov** or by phone at 502-564-2874.

EMPLOYEE RIGHTS UNDER THE FAIR LABOR STANDARDS ACT

THE UNITED STATES DEPARTMENT OF LABOR WAGE AND HOUR DIVISION

FEDERAL MINIMUM WAGE

\$7.25

 PER HOUR

BEGINNING JULY 24, 2009

OVERTIME PAY At least 1½ times your regular rate of pay for all hours worked over 40 in a workweek.

CHILD LABOR An employee must be at least **16** years old to work in most non-farm jobs and at least **18** to work in non-farm jobs declared hazardous by the Secretary of Labor.

Youths **14** and **15** years old may work outside school hours in various non-manufacturing, non-mining, non-hazardous jobs under the following conditions:

No more than

- **3** hours on a school day or **18** hours in a school week;
- **8** hours on a non-school day or **40** hours in a non-school week.

Also, work may not begin before **7 a.m.** or end after **7 p.m.**, except from June 1 through Labor Day, when evening hours are extended to **9 p.m.** Different rules apply in agricultural employment.

TIP CREDIT Employers of “tipped employees” must pay a cash wage of at least \$2.13 per hour if they claim a tip credit against their minimum wage obligation. If an employee’s tips combined with the employer’s cash wage of at least \$2.13 per hour do not equal the minimum hourly wage, the employer must make up the difference. Certain other conditions must also be met.

ENFORCEMENT The Department of Labor may recover back wages either administratively or through court action, for the employees that have been underpaid in violation of the law. Violations may result in civil or criminal action.

Employers may be assessed civil money penalties of up to \$1,100 for each willful or repeated violation of the minimum wage or overtime pay provisions of the law and up to \$11,000 for each employee who is the subject of a violation of the Act’s child labor provisions. In addition, a civil money penalty of up to \$50,000 may be assessed for each child labor violation that causes the death or serious injury of any minor employee, and such assessments may be doubled, up to \$100,000, when the violations are determined to be willful or repeated. The law also prohibits discriminating against or discharging workers who file a complaint or participate in any proceeding under the Act.

ADDITIONAL INFORMATION

- Certain occupations and establishments are exempt from the minimum wage and/or overtime pay provisions.
- Special provisions apply to workers in American Samoa and the Commonwealth of the Northern Mariana Islands.
- Some state laws provide greater employee protections; employers must comply with both.
- The law requires employers to display this poster where employees can readily see it.
- Employees under 20 years of age may be paid \$4.25 per hour during their first 90 consecutive calendar days of employment with an employer.
- Certain full-time students, student learners, apprentices, and workers with disabilities may be paid less than the minimum wage under special certificates issued by the Department of Labor.

For additional information:



1-866-4-USWAGE

(1-866-487-9243) TTY: 1-877-889-5627



WWW.WAGEHOUR.DOL.GOV

PART IV
INSURANCE

INSURANCE

The Contractor shall procure and maintain the following insurance in addition to the insurance required by law:

- 1) Commercial General Liability-Occurrence form – not less than \$2,000,000 General aggregate, \$2,000,000 Products & Completed Aggregate, \$1,000,000 Personal & Advertising, \$1,000,000 each occurrence.
- 2) Automobile Liability- \$1,000,000 per accident
- 3) Employers Liability:
 - a) \$100,000 Each Accident Bodily Injury
 - b) \$500,000 Policy limit Bodily Injury by Disease
 - c) \$100,000 Each Employee Bodily Injury by Disease
- 4) The insurance required above must be evidenced by a Certificate of Insurance and this Certificate of Insurance must contain one of the following statements:
 - a) "policy contains no deductible clauses."
 - b) "policy contains _____ (amount) deductible property damage clause but company will pay claim and collect the deductible from the insured."
- 5) KENTUCKY WORKMEN'S COMPENSATION INSURANCE. The contractor shall furnish evidence of coverage of all his employees or give evidence of self-insurance by submitting a copy of a certificate issued by the Workmen's Compensation Board.

The cost of insurance is incidental to all contract items. All subcontractors must meet the same minimum insurance requirements.

PART V
BID ITEMS

PROPOSAL BID ITEMS

192126

Page 1 of 2

Report Date 2/27/19

Section: 0001 - PAVING

LINE	BID CODE	ALT	DESCRIPTION	QUANTITY	UNIT	UNIT PRIC	FP	AMOUNT
0010	00190		LEVELING & WEDGING PG64-22	1,067.00	TON		\$	
0020	00307		CL2 ASPH SURF 0.38B PG64-22	16,850.00	TON		\$	
0030	02562		TEMPORARY SIGNS	1,550.00	SQFT		\$	
0040	02650		MAINTAIN & CONTROL TRAFFIC (KY 22, 000-008)	1.00	LS		\$	
0050	02650		MAINTAIN & CONTROL TRAFFIC (KY 22, 009-0017)	1.00	LS		\$	
0060	02650		MAINTAIN & CONTROL TRAFFIC (KY 241)	1.00	LS		\$	
0070	02650		MAINTAIN & CONTROL TRAFFIC (US 421 007-011)	1.00	LS		\$	
0080	02650		MAINTAIN & CONTROL TRAFFIC (US 421, 000-001)	1.00	LS		\$	
0090	02676		MOBILIZATION FOR MILL & TEXT	1.00	LS		\$	
0100	02676		MOBILIZATION FOR MILL & TEXT (KY 22, 000-008)	1.00	LS		\$	
0110	02676		MOBILIZATION FOR MILL & TEXT (KY 241)	1.00	LS		\$	
0120	02676		MOBILIZATION FOR MILL & TEXT (US 421, 000-001)	1.00	LS		\$	
0130	02676		MOBILIZATION FOR MILL & TEXT (US 421, 007-001)	1.00	LS		\$	
0140	02677		ASPHALT PAVE MILLING & TEXTURING	4,600.00	TON		\$	
0150	02696		SHOULDER RUMBLE STRIPS	21,400.00	LF		\$	
0160	02697		EDGE LINE RUMBLE STRIPS	140,842.00	LF		\$	
0170	03240		BASE FAILURE REPAIR	2,555.00	SQYD		\$	
0180	04792		CONDUIT-1 IN	40.00	LF		\$	
0190	04811		ELECTRICAL JUNCTION BOX TYPE B	4.00	EACH		\$	
0200	04820		TRENCHING AND BACKFILLING	65.00	LF		\$	
0210	04830		LOOP WIRE	1,590.00	LF		\$	
0220	04850		CABLE-NO. 14/1 PAIR	590.00	LF		\$	
0230	04895		LOOP SAW SLOT AND FILL	665.00	LF		\$	
0240	04960		REMOVE AND REPLACE SIDEWALK	3.00	SQYD		\$	
0250	06510		PAVE STRIPING-TEMP PAINT-4 IN	124,000.00	LF		\$	
0260	06514		PAVE STRIPING-PERM PAINT-4 IN	367,500.00	LF		\$	
0270	06544		PAVE STRIPING-THERMO-8 IN W	500.00	LF		\$	
0280	06565		PAVE MARKING-THERMO X-WALK-6 IN	515.00	LF		\$	
0290	06568		PAVE MARKING-THERMO STOP BAR-24IN	426.00	LF		\$	
0300	06574		PAVE MARKING-THERMO CURV ARROW	6.00	EACH		\$	
0310	10020NS		FUEL ADJUSTMENT	20,412.00	DOLL	\$1.00	\$	\$20,412.00
0320	10030NS		ASPHALT ADJUSTMENT	51,271.00	DOLL	\$1.00	\$	\$51,271.00
0330	20458ES403		CENTERLINE RUMBLE STRIPS	14,871.00	LF		\$	
0340	22520EN		PAVE MARKING-THERMO YIELD BAR-36 IN	30.00	LF		\$	
0350	24900EC		PVC CONDUIT-1 1/4 IN-SCHEDULE 80	65.00	LF		\$	
0360	24963ED		LOOP TEST	5.00	EACH		\$	
0370	24970EC		ASPHALT MATERIAL FOR TACK NON-TRACKING	90.00	TON		\$	

192126

PROPOSAL BID ITEMS

Page 2 of 2

Report Date 2/27/19

Section: 0002 - DEMOBILIZATION

LINE	BID CODE	ALT	DESCRIPTION	QUANTITY	UNIT	UNIT PRIC	FP	AMOUNT
0380	02569		DEMOBILIZATION	1.00	LS		\$	